



COMMERCIAL
RESIDENTIAL
COPPER
FIBER
STRUCTURED
CABLING
SOLUTIONS



CATALOG

<p>WORK AREA OUTLETS</p> <p>CAT 6A/6/5e connectors04</p> <p>Integrated VDV outlets 10</p> <p>Audio/Video connectors 12</p> <p>Configurable faceplates 18</p> <p>Decorex™ faceplates21</p> <p>Surface mount jacks.....24</p> <p>Mounting boxes27</p> <p>Surface mount boxes28</p> <p>Mobile patch boxes29</p> <p>MUTOA outlets.....30</p>	<p>PATCH PANELS & CROSS-CONNECT</p> <p>CAT 6A patch panels32</p> <p>CAT 6/5e patch panels34</p> <p>Wall mountable panels34</p> <p>Feed-through panels36</p> <p>Configurable blank panels37</p> <p>Telco panels39</p> <p>110 wiring blocks40</p> <p>110 patch panels42</p> <p>66 wiring blocks.....44</p>	<p>PREMISE CABLES</p> <p>CAT 6A UTP/FTP48</p> <p>CAT 6e UTP.....48</p> <p>CAT 6 UTP50</p> <p>CAT 5e50</p>
<p>RACKS & CABLE MANAGEMENT</p> <p>Wall mount racks54</p> <p>Floor mount racks59</p> <p>Vertical cable managers.....60</p> <p>Horizontal cable managers...62</p> <p>Plastic rings.....64</p> <p>Metal rings.....65</p> <p>Shelves66</p> <p>J-Hooks68</p> <p>Ladder Rack.....70</p>	<p>CORDS & CABLE ASSEMBLIES</p> <p>CAT 6A patch cords72</p> <p>CAT 6 patch cords72</p> <p>CAT 5e patch cords73</p> <p>110 patch cords74</p> <p>Telco cables75</p> <p>Modular plugs76</p> <p>Voice line cords77</p> <p>Velcro® brand cable ties.....78</p> <p>Nylon cable ties79</p>	<p>FIBER OPTIC SYSTEM</p> <p>Plug and Play cassettes82</p> <p>Adapters84</p> <p>Patch panels85</p> <p>Rack mount enclosures.....86</p> <p>Wall mount enclosures89</p> <p>Splice trays90</p> <p>Couplers91</p> <p>MUTOA boxes92</p> <p>Multimedia outlets93</p> <p>Cable assemblies94</p>
<p>RESIDENTIAL ENCLOSURES</p> <p>Metal enclosure combos96</p> <p>Plastic enclosure combos98</p> <p>Voice modules102</p> <p>CAT 6/5e data modules103</p> <p>Video modules.....104</p> <p>Multi-media patch panels ...105</p> <p>Electrical power strip.....105</p> <p>Electronics bracket.....105</p> <p>Cable management covers..105</p>	<p>TOOLS & ACCESSORIES</p> <p>JackEasy™ tool.....106</p> <p>110/66 punch-down tool107</p> <p>4-Pair punch-down tool108</p> <p>5-Pair punch-down tool108</p> <p>Cable stripping tools109</p> <p>Crimping tools.....109</p> <p>Compression tools110</p> <p>Compression connectors.....111</p> <p>Wire cutters112</p> <p>Raceway cutter112</p>	<p>RACEWAY</p> <p>Runway sections114</p> <p>Compatible outlets.....115</p> <p>Connecting accessories.....116</p> <p>Slotted wiring ducts117</p> <p>Solid wiring ducts117</p>
<p>PRE-TERMINATED CABLES</p> <p>HiPerLink™ copper118</p> <p>HiPerLink™ fiber optic.....119</p>	<p>INDEX</p> <p>Part number index.....120</p>	<p>WIRING DIAGRAMS</p> <p>T568A/B wiring122</p>

ICC is an independent and privately owned California corporation. ICC has been manufacturing structured cabling products for small and mid-size installers since 1984.



HD or EZ®

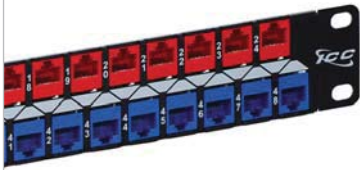

High Density
Up to 48-Ports in 1 RMS



Easy
Easy to lay wires



HD Outlets
Decorex™ and Furniture



EZ® Outlets
Classic and Furniture



HD Panels
Single row ports

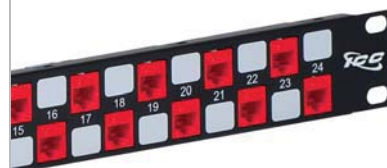

EZ® Panel
Staggered ports



One Tool



For Both

Be Green, Buy ValuePacks!

We created ValuePacks to shrink storage size, reduce packaging waste, and lower unit cost. Look for ValuePacks throughout the catalog to save space, save Mother Earth, and save money.

Connectors



Faceplates



Patch Cords



66 Blocks

CAT 6A 10G UTP MODULAR CONNECTORS HD STYLE

- Rear split-back IDC
- Shielded termination cap
- 50 micro-inch gold plated contacts

PART NO. IC1078GAxx¹ **DESCRIPTION** 8P8C, UTP **CARTON / CASE** 50 / 400



PERMANENT LINK PERFORMANCE TEST

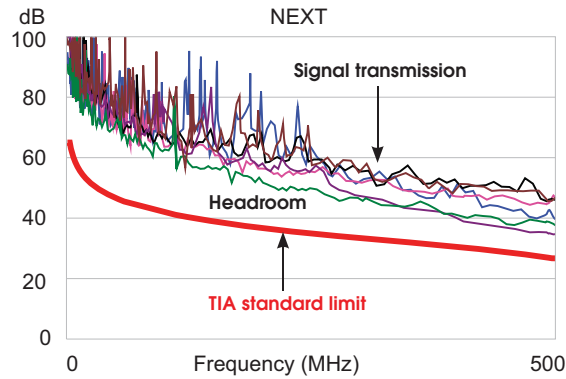

Installed with ICC premise cable and tested per TIA Permanent Link specification



CAT 6A 10G FTP MODULAR CONNECTOR HD STYLE

- 360° shielding from Electromagnetic Interference and Alien Crosstalk
- Rear split-back IDC
- 50 micro-inch gold plated contacts

PART NO. IC1078S6A0 **DESCRIPTION** 8P8C, FTP **CARTON / CASE** 50 / 400
ICACSGK6AS Grounding wire, 18 AWG, 7" length, **10 pcs.**

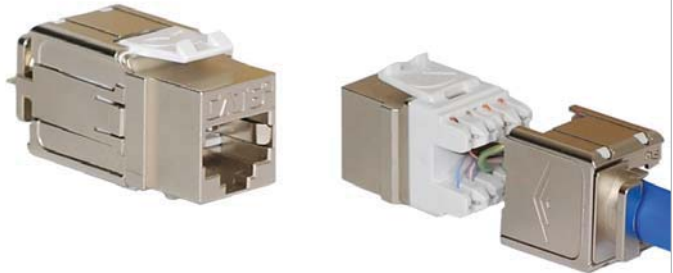

PERMANENT LINK PERFORMANCE TEST

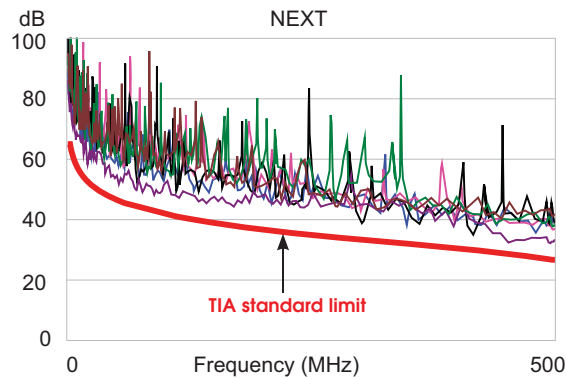

Installed with ICC premise cable and tested per TIA Permanent Link specification



CAT 6A 10G UTP MODULAR COUPLER HD STYLE

- No termination required; feed-through the front and rear
- Joins two high performance CAT 6A patch cords
- 50 micro-inch gold plated contacts

PART NO. IC107C6Axx¹ **DESCRIPTION** 8P8C, UTP **CARTON / CASE** 50 / 400

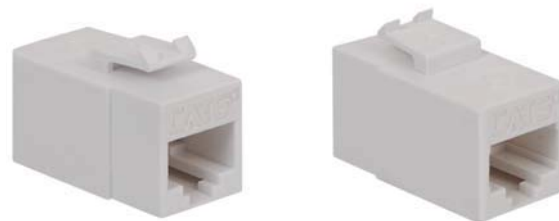
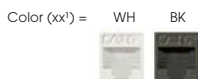

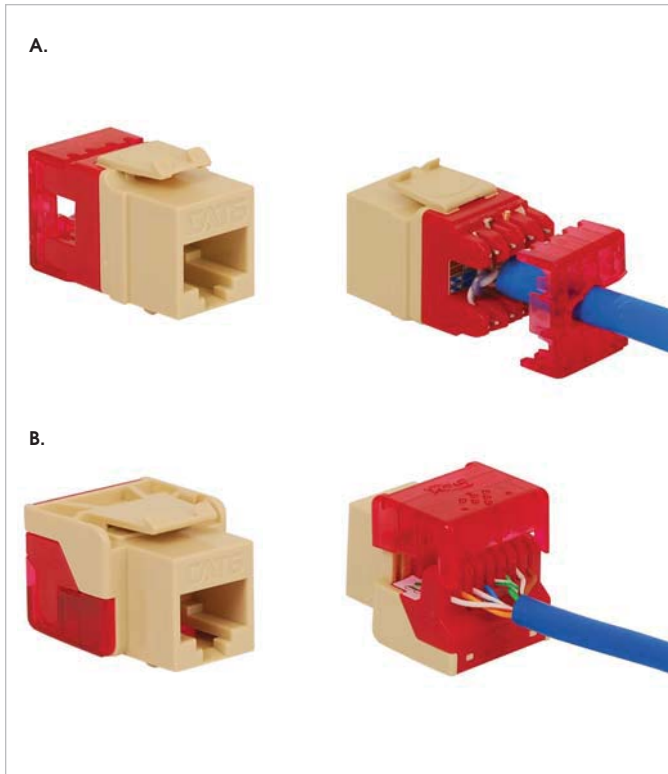

CAT 6 HD AND EZ® STYLE MODULAR CONNECTORS

- Exceeds TIA-568 CAT 6 performance standard
- Built-in PCB technology for maximum signal quality
- 50 micro-inch gold plated contacts
- Includes a color T568A/B wiring diagram
- Terminate with the JackEasy termination tool

PART NO.	DESCRIPTION	CARTON / CASE
A. IC1078F6xx¹	8P8C, HD style	50 / 400
B. IC1078L6xx¹	8P8C, EZ style	50 / 400

Color (xx¹) =

WH	IV	BL	OR	RD	YL	GY	BK	AL	GN	PR

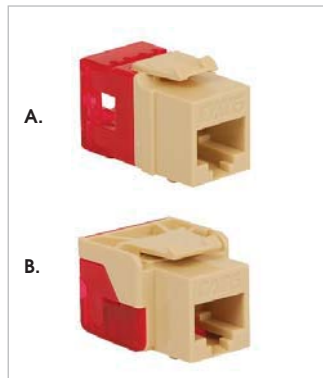

CAT 6 HD AND EZ® STYLE MODULAR CONNECTOR VALUEPACKS

- Packaged in a resealable bag for easy storage
- Reduces packaging waste
- 25 pieces per bag

PART NO.	DESCRIPTION	CARTON / CASE
A. IC107F6Cxx¹	8P8C, HD style , 25 pcs.	10 / 40
B. IC107L6Cxx¹	8P8C, EZ style, 25 pcs.	10 / 40

Color (xx¹) =

WH	IV	BL	OR	RD	BK



CAT 6 MODULAR COUPLERS HD STYLE

- No termination required; feed-through the front and rear
- Exceeds TIA-568 CAT 6 performance standard
- 50 micro-inch gold plated contacts

PART NO.	DESCRIPTION	CARTON / CASE
IC107CP6xx¹	8P8C	50 / 400

Color (xx¹) =

WH	BK



CAT 6 MODULAR COUPLER HD STYLE VALUEPACKS

- Packaged in a resealable bag for easy storage
- Reduces packaging waste
- 25 pieces per bag

PART NO.	DESCRIPTION	CARTON / CASE
IC107C6Cxx¹	8P8C, 25 pcs.	10 / 40

Color (xx¹) =

WH	BK

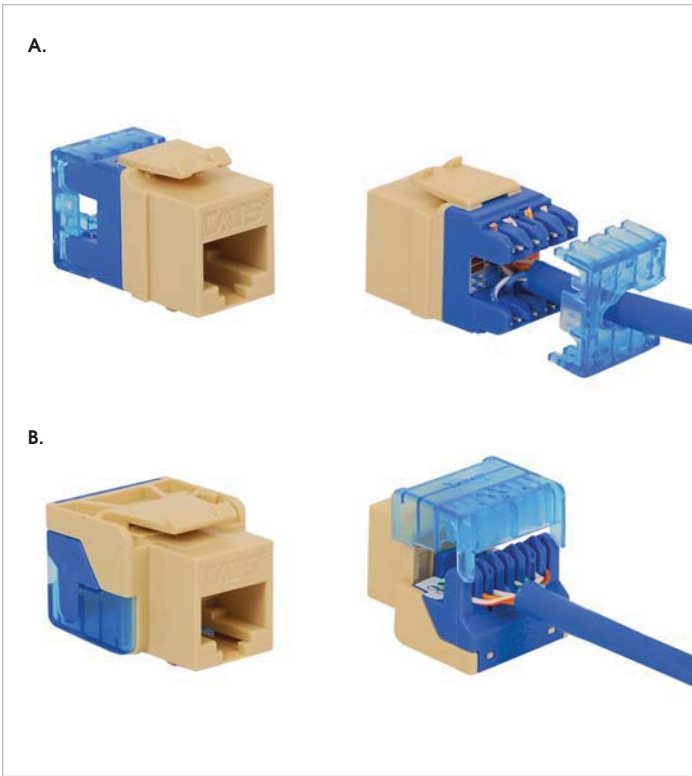

CAT 5e HD AND EZ® STYLE MODULAR CONNECTORS

- Exceeds TIA-568 CAT 5e performance standard
- Built-in PCB technology for maximum signal quality
- 50 micro-inch gold plated contacts
- Includes a color T568A/B wiring diagram
- Compatible with VoIP phone systems
- Terminate with the JackEasy termination tool

PART NO.	DESCRIPTION	CARTON / CASE
A. IC1078F5xx¹	8P8C, HD style	50 / 400

- Rear split-back IDC

B. IC1078E5xx¹	8P8C, EZ style	50 / 400
----------------------------------	----------------	----------

- Rear in-line IDC makes seating wires easy
- Pair-to-pair wiring; no splitting

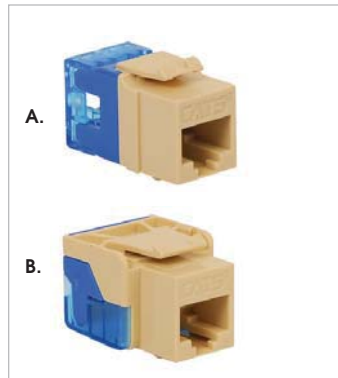

CAT 5e HD AND EZ® STYLE MODULAR CONNECTOR VALUEPACKS

- Packaged in a resealable bag for easy storage
- Reduces packaging waste
- 25 pieces per bag

PART NO.	DESCRIPTION	CARTON / CASE
A. IC107F5Cxx¹	8P8C, HD style, 25 pcs.	10 / 40
B. IC107E5Cxx¹	8P8C, EZ style, 25 pcs.	10 / 40



CAT 5e MODULAR COUPLERS HD STYLE

- No termination required; feed-through the front and rear
- Exceeds TIA-568 CAT 5e performance standard
- 50 micro-inch gold plated contacts

PART NO.	DESCRIPTION	CARTON / CASE
IC107C5Exx¹	8P8C	50 / 400

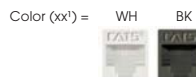

CAT 5e MODULAR COUPLER HD STYLE VALUEPACKS

- Packaged in a resealable bag for easy storage
- Reduces packaging waste
- 25 pieces per bag

PART NO.	DESCRIPTION	CARTON / CASE
IC107C5Cxx¹	8P8C, 25 pcs.	10 / 40

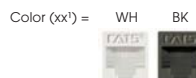

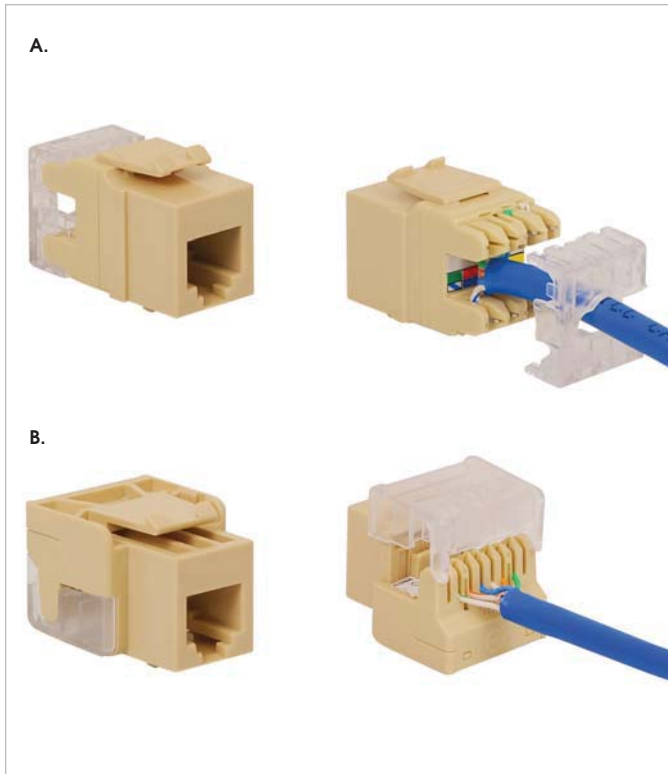

VOICE HD AND EZ® STYLE MODULAR CONNECTORS

- Supports phone applications
- Compatible with RJ-11 plug
- Accepts category-rated cable and 22~24 AWG solid wire
- 50 micro-inch gold plated contacts
- Includes a color USOC/UTP wiring diagram
- Terminate with the JackEasy termination tool

PART NO.	DESCRIPTION	CARTON / CASE
A. IC1076F0xx¹	6P6C, HD style	50 / 400
• Rear split-back IDC		
B. IC1076V0xx¹	6P6C, EZ style	50 / 400
• Rear in-line IDC makes seating wires easy		
Color (xx ¹) =	WH IV BL OR RD YL GY BK AL GN PR	

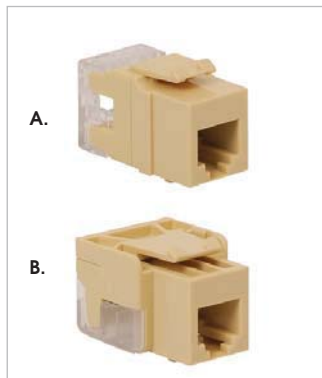

VOICE HD AND EZ® STYLE MODULAR CONNECTOR VALUEPACKS

- Packaged in a resealable bag for easy storage
- Reduces packaging waste
- 25 pieces per bag

PART NO.	DESCRIPTION	CARTON / CASE
A. IC1076FCxx¹	6P6C, HD style, 25 pcs.	10 / 40
B. IC1076VCxx¹	6P6C, EZ style, 25 pcs.	10 / 40
Color (xx ¹) =	WH IV	

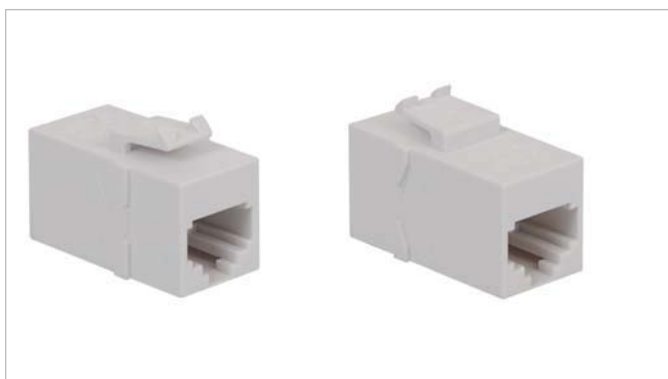

VOICE MODULAR COUPLERS HD STYLE

- No termination required; feed-through on the front and rear
- Supports phone applications
- Compatible with RJ-11 plug
- 50 micro-inch gold plated contacts

PART NO.	DESCRIPTION	CARTON / CASE
IC107C6Sxx¹	6P6C, Pin 1-6	50 / 400
IC107C6Rxx¹	6P6C, Pin 1-1	50 / 400
Color (xx ¹) =	WH IV GY BK	



One Vendor, No Compatibility Issue

We fine tune premise cables and connectivity outlets to work together as End-to-End solutions.

FIBER OPTIC MODULAR COUPLERS HD STYLE

- Female to female coupler
- Feed-through on the front and rear; no termination required
- Designed with ceramic sleeves
- Supports multimode and single-mode

PART NO.	DESCRIPTION	CARTON / CASE
A. IC107LC2xx ¹	LC duplex coupler, ceramic sleeves	50 / 400
B. IC107SC2xx ¹	SC simplex coupler, ceramic sleeve	50 / 400
C. IC107ST2xx ¹	ST simplex coupler, ceramic sleeve	50 / 400

Color (xx¹) = WH IV

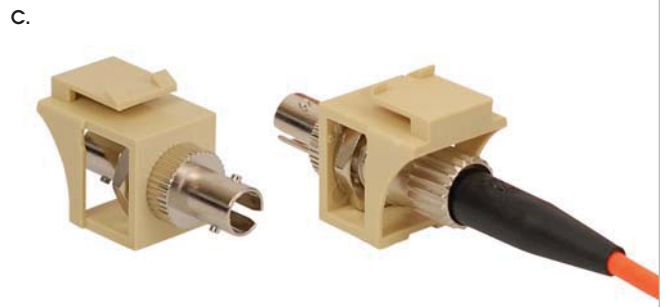
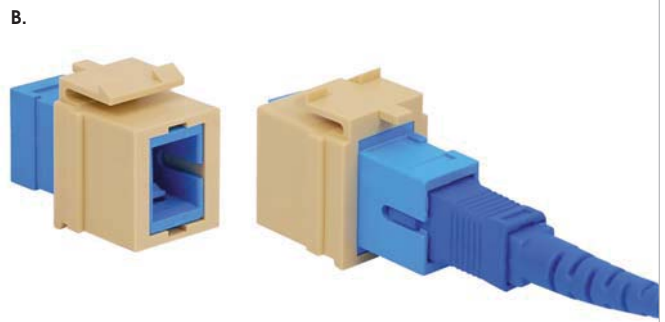
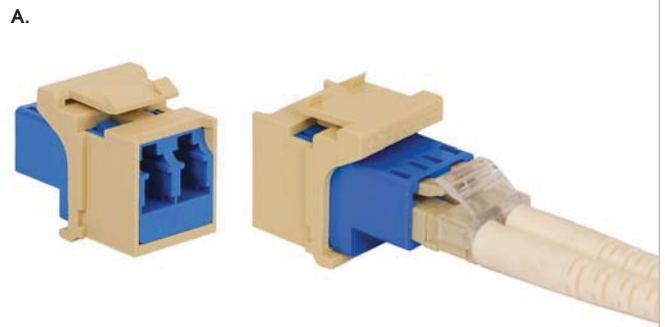

FIBER OPTIC COUPLERS IN ELITE™ SURFACE MOUNT BOXES

Elite surface mount box →
Page 28

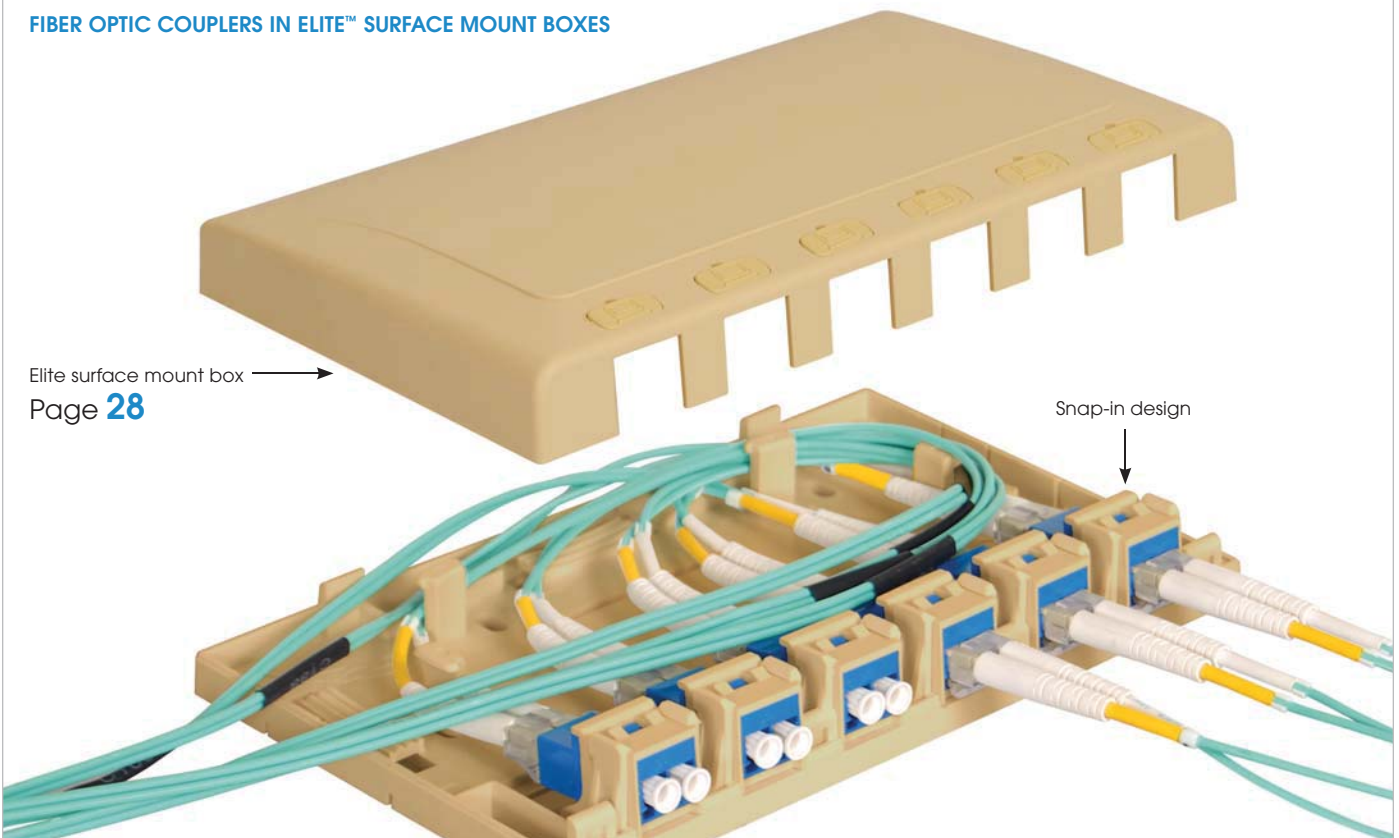

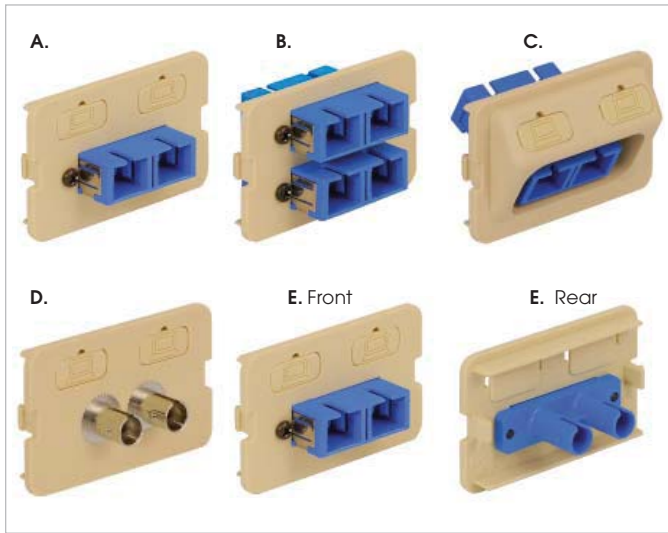

FIBER OPTIC ELITE™ BEZELS

- Fiber couplers are integrated into the bezel
- Designed with metal sleeves
- Install bezels in Elite™ series faceplates, outlets and MUTOA boxes
- Package includes icons

PART NO.	DESCRIPTION
A. IC108BFCxx ¹	SC duplex to SC duplex, flat
B. IC108BFDxx ¹	2 SC duplex to SC duplex, flat
C. IC108BACxx ¹	SC duplex to SC duplex, angled
D. IC108BFTxx ¹	ST duplex to ST duplex, flat
E. IC108BFRxx ¹	SC duplex to ST duplex, flat

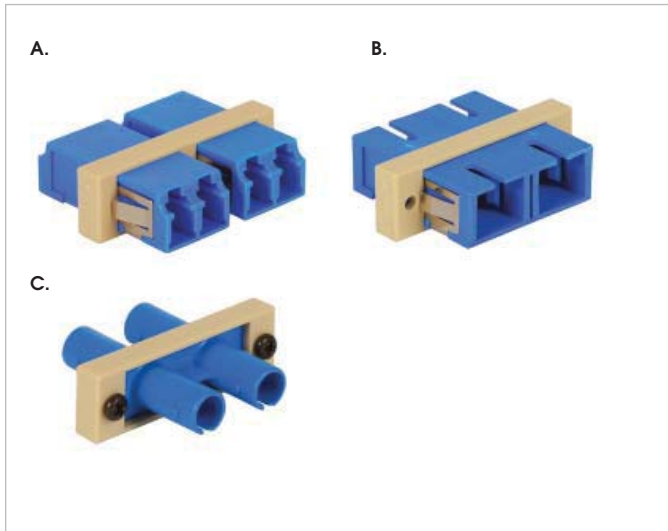
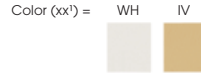

FIBER OPTIC SLIM BEZELS

- Fiber couplers are integrated into the bezel
- Install slim bezels inside the bottom of Elite™ multimedia outlets

PART NO.	DESCRIPTION
A. ICFOBWLbxx ¹	Dual LC duplex to LC duplex, metal sleeves
B. ICFOBWCbxx ¹	SC duplex to SC duplex, metal sleeves
C. ICFOBWTbxx ¹	ST duplex to ST duplex, metal sleeves



ELITE™ MULTIMEDIA OUTLETS AND MUTOA BOXES ARE CONFIGURABLE WITH ELITE BEZELS AND SLIM BEZELS

Elite multimedia outlet
Page 31

Slim bezels mount inside the bottom of multimedia outlets allowing fiber to enter and exit vertically.

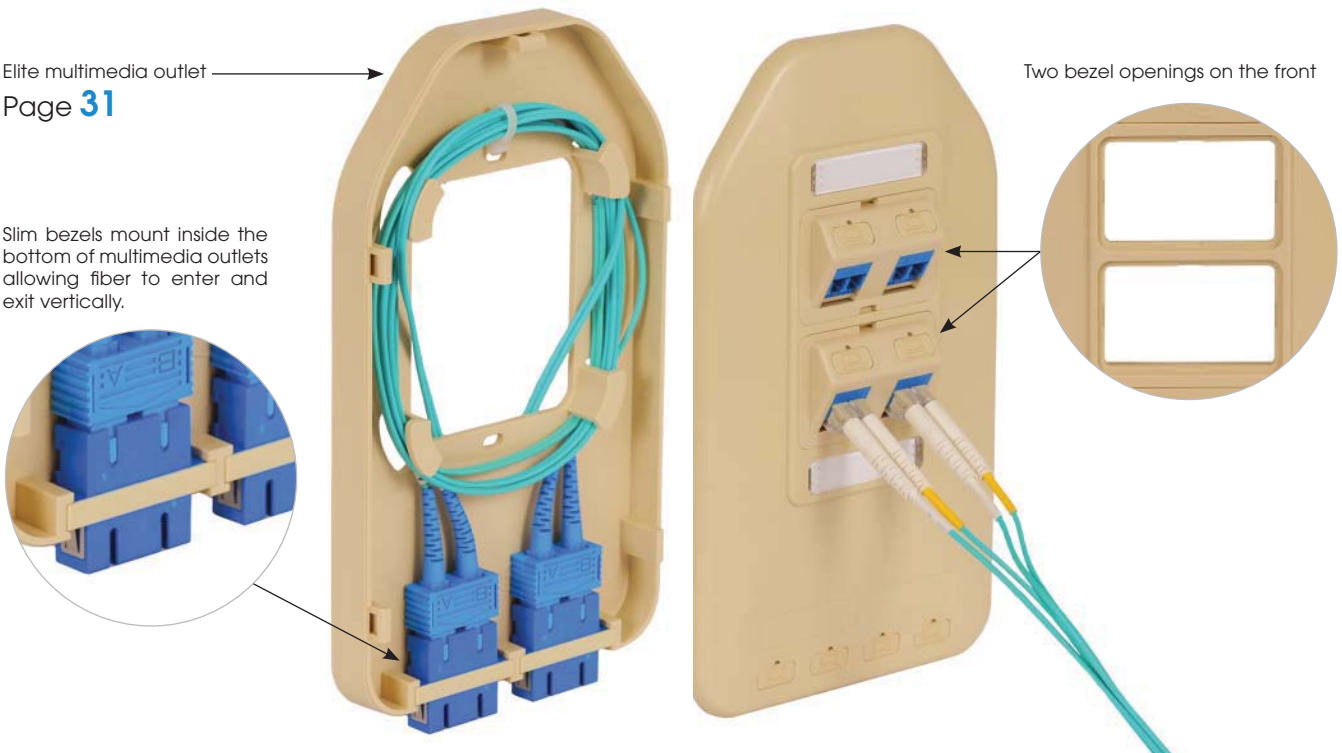

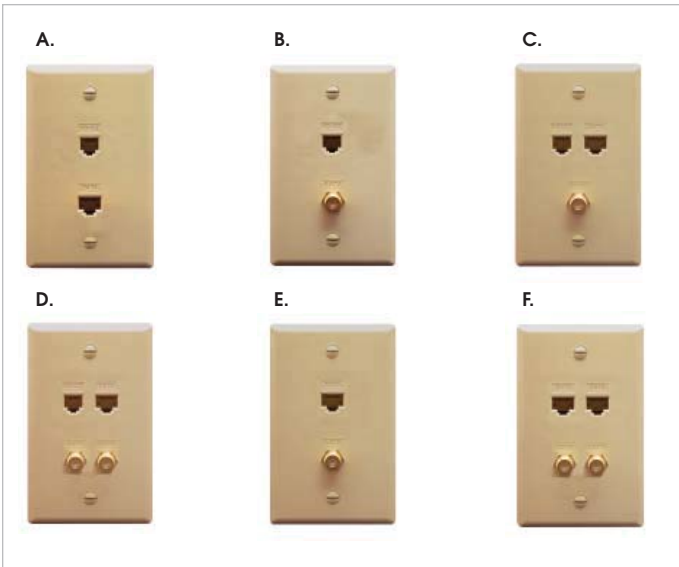

INTEGRATED FACEPLATES WITH VOICE, CAT 5e DATA AND VIDEO

- Integrate all the connectivity into one faceplate
- One-piece design; no assembly required
- Designed with rear 110-Type IDC for fast termination
- Durable ABS plastic body
- 50 micro-inch gold plated contacts
- Package includes retention caps to secure wiring

PART NO.	DESCRIPTION	CARTON / CASE
A. ICRDSV05xx ¹	6P6C voice and CAT 5e data	25 / 100
B. ICRDSVF0xx ¹	6P6C voice and F-Type video	25 / 100
C. ICRDSVF5xx ¹	6P6C voice, CAT 5e data and F-Type video	25 / 100
D. ICRDSV25xx ¹	6P6C voice, CAT 5e data and 2 F-Type video	25 / 100
E. ICRDS0F5xx ¹	CAT 5e data and F-Type video	25 / 100
F. ICRDS2F5xx ¹	2 CAT 5e data and 2 F-Type video	25 / 100

Color (xx) = WH IV AL

FACEPLATE FEATURES



← IDC contacts



← Retention caps

INTEGRATED FACEPLATE FEATURES

All ports are embossed to identify applications. All modular connectors have 50 micro inch gold plated contacts for maximum performance.



Voice Port

- Supports:
- Phones
 - Fax machines



CAT 5e Data Port

- Supports:
- Home networking
 - 1 Gigabit per second
 - High speed internet



F-Type Port

- Supports:
- 2 GHz bandwidth
 - Televisions
 - Satellite
 - Cable



← 50 GOLD



CLASSIC SURFACE MOUNT BOXES KITTED WITH VOICE AND CAT 5e DATA MODULAR CONNECTORS

- Comes with a voice or CAT 5e, EZ® style, modular connector
- Connectors are removable
- Package includes adhesive strips and wood screws for mounting

Color (xx) = WH IV

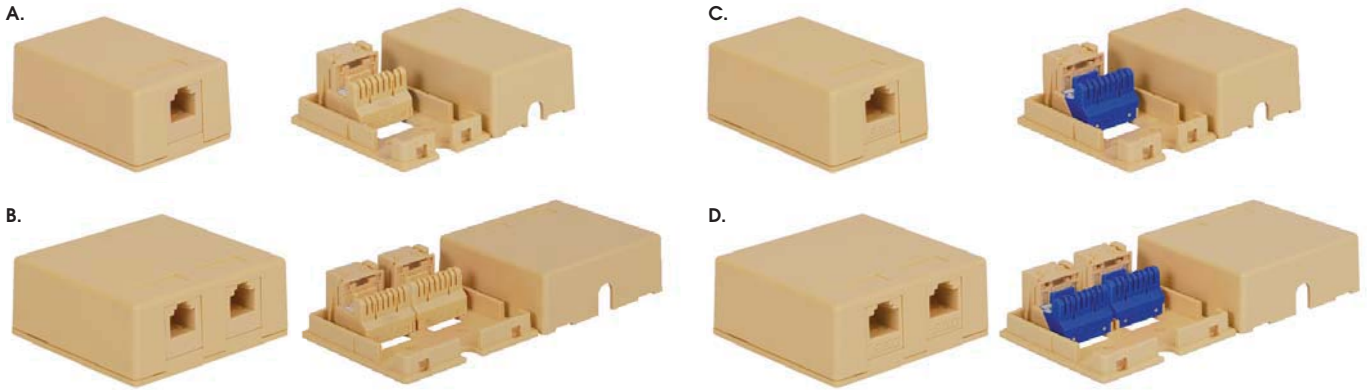
PART NO. A. IC625SV1xx¹ 1-Port box, with voice EZ connector
DESCRIPTION B. IC625SV2xx¹ 2-Port box with 2 voice EZ connectors

C. IC625S51xx¹ 1-Port box with CAT 5e EZ connector
D. IC625S52xx¹ 2-Port box with 2 CAT 5e EZ connectors

SURFACE MOUNT BOX KIT FEATURES



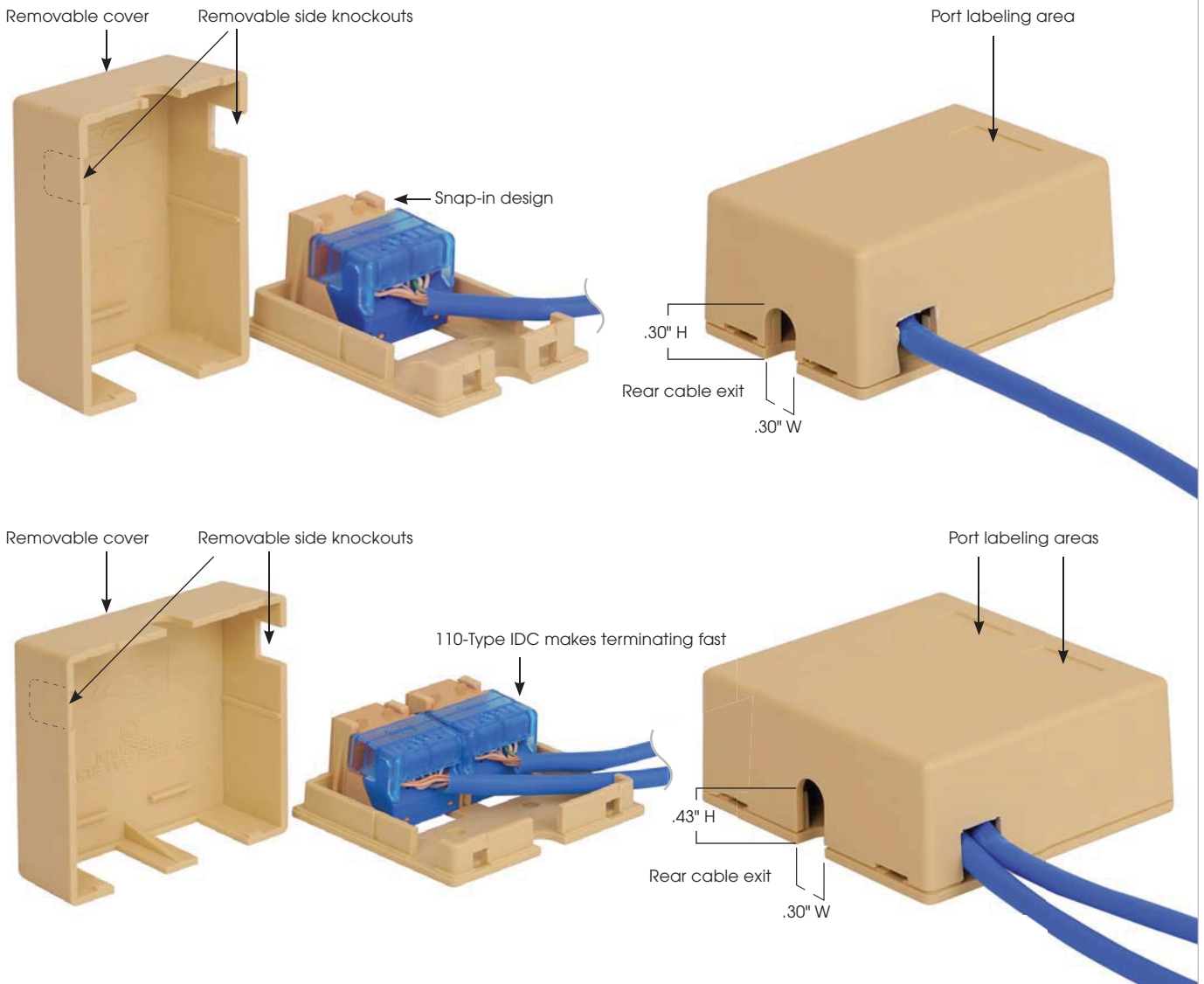

HDMI MODULAR COUPLERS HD STYLE

- Female to female gold plated coupler
- Supports high-definition video: 1080p, 3D and HDCP

PART NO. IC107HDMxx¹	DESCRIPTION HDMI connector	CARTON / CASE 50 / 400								
Color (xx ¹) =	<table border="0"> <tr> <td>WH</td> <td>IV</td> <td>BK</td> <td>AL</td> </tr> <tr> <td></td> <td></td> <td></td> <td></td> </tr> </table>	WH	IV	BK	AL					
WH	IV	BK	AL							
										

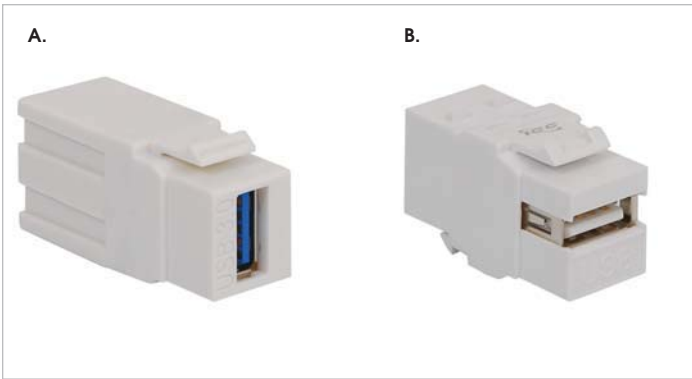

USB MODULAR COUPLERS HD STYLE

- Female to female coupler





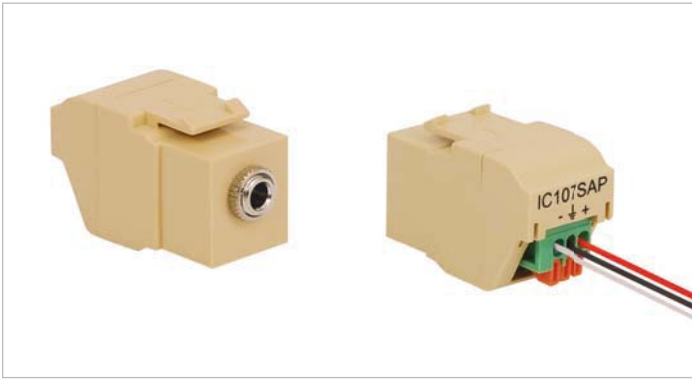







PART NO. A. IC107UAAWH	DESCRIPTION USB coupler, A-to-A	CARTON / CASE 50 / 400
	<ul style="list-style-type: none"> • Supports USB connectivity; backwards compatible 	
B. IC107UABWH	USB coupler, A-to-B	50 / 400
	<ul style="list-style-type: none"> • Supports USB connectivity • Reversible coupler with either the A or B port facing outward 	

Color	=	White
		



3.5mm STEREO AUDIO PLUG MODULAR CONNECTORS HD STYLE

- Rear push-pins accept UTP cable or any 22-24 AWG wire
- Terminals are marked for correct polarity

PART NO. IC107SAPxx¹	DESCRIPTION 3.5mm connector to push pin	CARTON / CASE 50 / 400								
Color (xx ¹) =	<table border="0"> <tr> <td>WH</td> <td>IV</td> <td>BK</td> <td>AL</td> </tr> <tr> <td></td> <td></td> <td></td> <td></td> </tr> </table>	WH	IV	BK	AL					
WH	IV	BK	AL							
										



3.5mm STEREO AUDIO PLUG MODULAR COUPLERS HD STYLE

- Female to female nickel plated coupler

PART NO. IC107SACWH	DESCRIPTION 3.5mm coupler, feed-through	CARTON / CASE 50 / 400
Color	=	White
		



S-VIDEO MODULAR CONNECTORS HD STYLE

- Front female connector with rear 110-Type IDC termination
- Rear IDC accepts UTP cable or any 22-24 AWG wire
- Package includes a termination cap to secure wiring

PART NO. IC107SVIxx¹	DESCRIPTION S-Video connector	CARTON / CASE 50 / 400								
Color (xx ¹) =	<table border="0"> <tr> <td>WH</td> <td>IV</td> <td>BK</td> <td>AL</td> </tr> <tr> <td></td> <td></td> <td></td> <td></td> </tr> </table>	WH	IV	BK	AL					
WH	IV	BK	AL							
										



HDMI DÉCOREX™ INSERTS WITH 2 OPEN HIGH DENSITY PORTS

- Female to female gold plated coupler
- Supports high-definition video: 1080p, 3D and HDCP
- Package includes 2 blank modular inserts

PART NO. IC107DH2xx¹ **DESCRIPTION** 1 HDMI coupler, 2 HD ports

CARTON / CASE
25 / 200



DUAL HDMI DÉCOREX INSERTS WITH 2 OPEN HIGH DENSITY PORTS

- Female to female gold plated couplers
- Supports high-definition video: 1080p, 3D and HDCP
- Package includes 2 blank modular inserts

PART NO. IC107DDHxx¹ **DESCRIPTION** 2 HDMI couplers, 2 HD ports

CARTON / CASE
25 / 200



VGA DÉCOREX INSERTS WITH 2 OPEN HIGH DENSITY PORTS

- Female to female 15-Pin VGA coupler
- Supports high quality analog video
- Package includes 2 blank modular inserts

PART NO. IC107DR2xx¹ **DESCRIPTION** 1 VGA coupler, 2 HD ports

CARTON / CASE
25 / 200



VGA DÉCOREX INSERTS WITH 4 OPEN HIGH DENSITY PORTS

- Female to female 15-Pin VGA coupler
- Supports high quality analog video
- Package includes 4 blank modular inserts

PART NO. IC107DR4xx¹ **DESCRIPTION** 1 VGA coupler, 4 HD ports

CARTON / CASE
25 / 200



VGA Décorex Inserts

Connecting to computer monitors, projectors and flat screen TV's from the wall outlet.



F-TYPE VIDEO MODULAR CONNECTORS HD STYLE

- Female to female feed-through connector
- Threaded connector to secure connection
- Works with RG-6 and RG-59 coaxial cable

PART NO.	DESCRIPTION	CARTON / CASE
A. IC107B9Fxx ¹	F-Type nickel plated, 3 GHz (pictured)	50 / 400
IC107B9Gxx ¹	F-Type gold plated, 3 GHz	50 / 400
IC107B5Fxx ²	F-Type nickel plated, 2 GHz	50 / 400
IC107B5Gxx ²	F-Type gold plated, 2 GHz	50 / 400

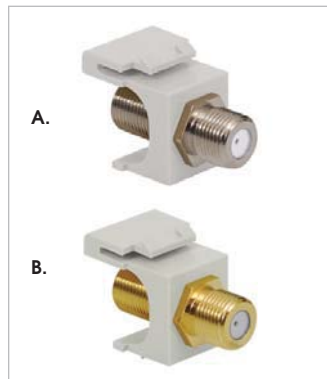

F-TYPE VIDEO MODULAR CONNECTOR HD STYLE VALUEPACKS

- Packaged in a resealable bag for easy storage
- Reduces packaging waste
- 25 pieces per bag

PART NO.	DESCRIPTION	CARTON / CASE
A. IC107BFCWH	F-Type nickel plated, 2 GHz, 25 pcs.	10 / 40
B. IC107BGCWH	F-Type gold plated, 2 GHz, 25 pcs.	10 / 40



F-TYPE VIDEO MODULAR COMPRESSION CONNECTOR HD STYLE

- Front female nickel plated connector with rear compression connector
- Rear compression connector works with RG-6 quad shield coaxial cable
- Not compatible with plenum cable

PART NO.	DESCRIPTION	CARTON / CASE
IC107FQGWH	F-Type, RG-6Q, blue band	50 / 400



BNC VIDEO MODULAR CONNECTORS HD STYLE

- Female to female feed-through nickel plated connector
- Supports CCTV, NTSC Analog video signals and satellite link signals

PART NO.	DESCRIPTION	CARTON / CASE
IC107BNCxx ¹	BNC connector, 75 Ohm	50 / 400
IC107B3Gxx ¹	BNC connector, 50 Ohm	50 / 400

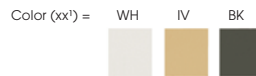

BNC VIDEO MODULAR COMPRESSION CONNECTOR HD STYLE

- Front female nickel plated connector with rear compression connector
- Rear compression connector works with RG-6 quad shield coaxial cable
- Not compatible with plenum cable

PART NO.	DESCRIPTION	CARTON / CASE
IC107BQCWH	BNC, blue band, 75 Ohm	50 / 400





RCA FEMALE-TO-RCA FEMALE MODULAR CONNECTORS HD STYLE

- Female to female feed-through connector

PART NO.	DESCRIPTION	CARTON / CASE
A. IC107R6Gxx ¹	Red insert (pictured)	50 / 400
IC107G6Gxx ¹	Green insert	50 / 400
IC107L6Gxx ¹	Blue insert	50 / 400
IC107B6Gxx ¹	White insert	50 / 400
IC107Y6Gxx ¹	Yellow insert	50 / 400
IC107K6Gxx ¹	Black insert	50 / 400



RCA FEMALE-TO-F-TYPE MODULAR CONNECTORS HD STYLE

- Front female connector with rear F-Type female connector
- Rear connector works with RG-6 and RG-59 coaxial cable

PART NO.	DESCRIPTION	CARTON / CASE
A. IC107RFGxx ¹	Red Insert (pictured)	50 / 400
IC107GFGxx ¹	Green Insert	50 / 400
IC107LFGxx ¹	Blue Insert	50 / 400
IC107BFGxx ¹	White Insert	50 / 400
IC107YFGxx ¹	Yellow Insert	50 / 400
IC107KFGxx ¹	Black Insert	50 / 400

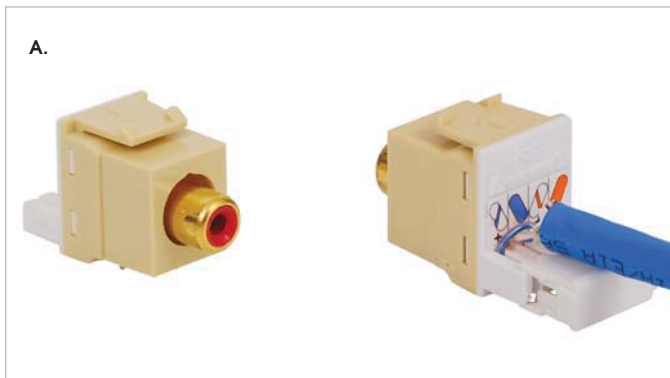

RCA FEMALE-TO-IDC MODULAR CONNECTORS HD STYLE

- Front female connector with rear 110-Type IDC termination
- Rear IDC accepts UTP cable or any 22-24 AWG wire
- Package includes a termination cap to secure wiring

PART NO.	DESCRIPTION	CARTON / CASE
A. IC107R8Gxx ¹	Red insert (pictured)	50 / 400
IC107G8Gxx ¹	Green insert	50 / 400
IC107L8Gxx ¹	Blue insert	50 / 400
IC107B8Gxx ¹	White insert	50 / 400
IC107Y8Gxx ¹	Yellow insert	50 / 400
IC107K8Gxx ¹	Black insert	50 / 400

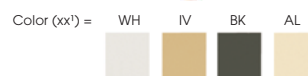

RCA MODULAR COMPRESSION CONNECTORS HD STYLE

- Front female nickel plated connector with rear compression connector
- Rear compression connector works with RG-6 quad shield coaxial cable
- Not compatible with plenum cable

PART NO.	DESCRIPTION	CARTON / CASE
A. IC107RQRWH	Red insert, blue band (pictured)	50 / 400
IC107RQGWH	Green insert, blue band	50 / 400
IC107RQLWH	Blue insert, blue band	50 / 400
IC107RQWWH	White insert, blue band	50 / 400
IC107RQYWH	Yellow insert, blue band	50 / 400
IC107RQKWH	Black insert, blue band	50 / 400



RCA SOLDER TAIL AND COMPONENT PACK MODULAR CONNECTORS

- | PART NO. | DESCRIPTION |
|----------------------------|--|
| A. IC107B7Gxx ¹ | Solder Tail, Black Insert, HD style |
| B. IC107RR5xx ² | Female to female connector, HD style, 5 pcs. (pictured) |
| IC107RF5xx ² | Front female with rear F-Type female, HD style, 5 pcs. |
| IC107RD5xx ² | Front female with rear 110-Type IDC termination, HD style, 5 pcs. |
- Front female connector with rear solder tail termination
 - Includes connectors with 2 red, 1 green, 1 blue and 1 white insert
 - 5 pieces per bag

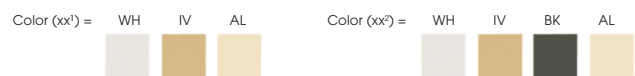

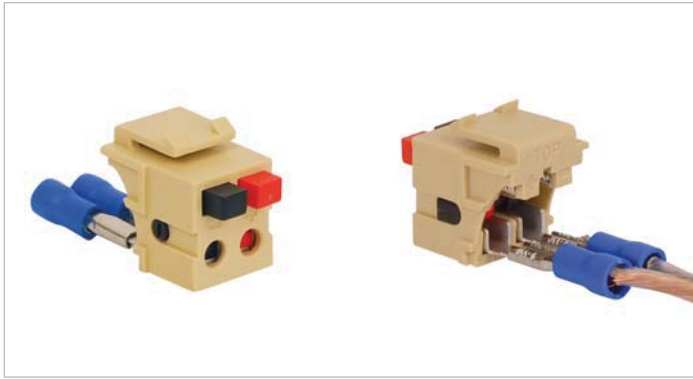

DUAL AUDIO SPEAKER MODULAR CONNECTORS HD STYLE

- Front push buttons with rear crimp-on wire connector
- Black and red push buttons have + and - signs for correct polarity
- Accepts speaker wire up to 16 AWG
- Patented design

PART NO. IC107DSCxx1 **DESCRIPTION** Front speaker connector

CARTON / CASE
50 / 400

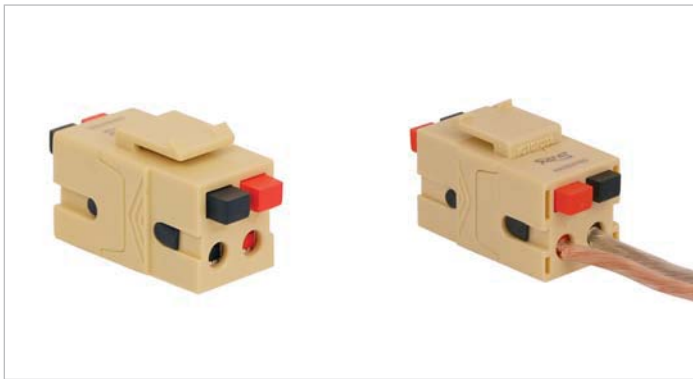

DUAL FRONT AND BACK AUDIO SPEAKER MODULAR CONNECTORS HD STYLE

- Front and rear push buttons
- Black and red push buttons have + and - signs for correct polarity
- Accepts speaker wire up to 16 AWG
- Patented design

PART NO. IC107DSBxx1 **DESCRIPTION** Front and rear speaker connector

CARTON / CASE
50 / 400

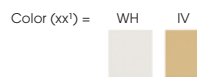

SPRING CLIP AUDIO SPEAKER MODULAR CONNECTORS HD STYLE

- Front spring clip with rear crimp-on wire connector
- Front accepts speaker wire up to 12 AWG
- Rear accepts speaker wire up to 16 AWG
- Comes in pairs with red and black clips for correct polarity
- Patented design

PART NO. IC107BSSBK **DESCRIPTION** Spring clip connectors

CARTON / CASE
50 / 400



BINDING POST AUDIO SPEAKER MODULAR CONNECTORS HD STYLE

- Front gold plated binding post with female banana plug
- Rear set-screw connection
- Accepts speaker wire up to 8 AWG
- Comes in pairs with red and black bands for correct polarity

PART NO. IC107PMGxx1 **DESCRIPTION** Binding post connectors, gold plated

CARTON / CASE
50 / 400



Home Theater Solution

Install 7.1 surround sound, high definition and component A/V as well as satellite and cable input in a Décorex™ quad-gang faceplate.



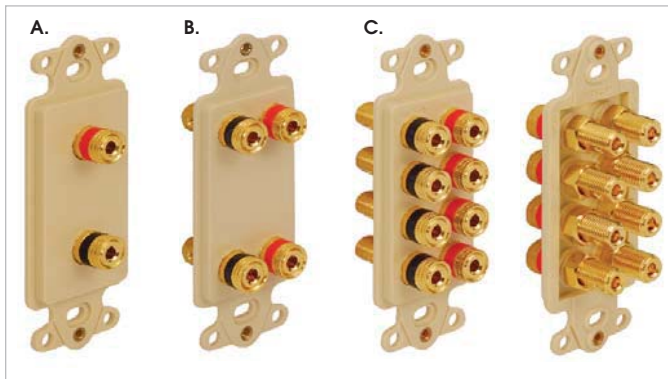

BINDING POST AUDIO SPEAKER DÉCOREX™ INSERTS

- Front gold plated binding post with female banana plug
- Rear set-screw connection
- Accepts speaker wire up to 8 AWG
- Red and black bands for correct polarity

PART NO.	DESCRIPTION
A. ICRDSSBPxx ¹	2 binding posts
B. ICRDSDBPxx ²	4 binding posts
C. ICRDSQBPxx ²	8 binding posts

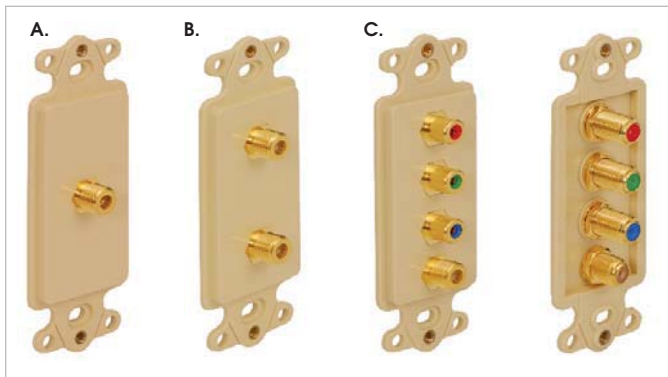

F-TYPE AND RCA DÉCOREX INSERTS

- | PART NO. | DESCRIPTION |
|----------------------------|---------------------------------------|
| A. IC630DSFxx ¹ | F-Type connector |
| B. IC630DDFxx ¹ | 2 F-Type connectors |
| C. ICRDS3RFxx ² | F-Type connector and 3 RCA connectors |
- Female to female F-Type connector
 - 3 RCA female connectors with rear F-Type connectors
 - Rear works with RG-6 and RG-59 coaxial cable



BLANK FILL-IN MODULAR INSERTS HD STYLE

- Fills open and unused ports until they are needed

PART NO.	DESCRIPTION	CARTON / CASE
A. IC107BN0xx ¹	Blank fill-in insert, 10 pcs.	25 / 200
B. IC107BNVxx ²	Blank fill-in insert, 100 pcs. VALUEPACK	



CABLE FEED-THROUGH MODULAR INSERTS HD STYLE

- Allows cable to pass through a 0.30 inch diameter hole

PART NO.	DESCRIPTION	CARTON / CASE
IC107BN2xx ¹	Cable feed-through insert, 10 pcs.	75 / 300

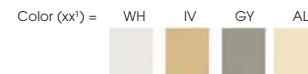

DUST COVER

- Works with CAT 6A, CAT 6, CAT 5e and voice modular connectors and patch panels
- Snaps on the port opening to prevent dust from entering

PART NO.	DESCRIPTION
ICACSDCICL	Dust cover, 10 pcs.
ICACSDCVCL	Dust cover, 100 pcs. VALUEPACK

Color = Clear

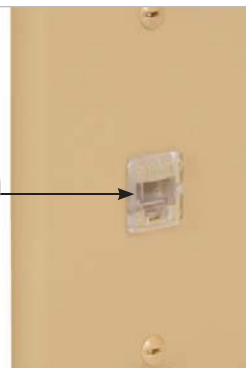

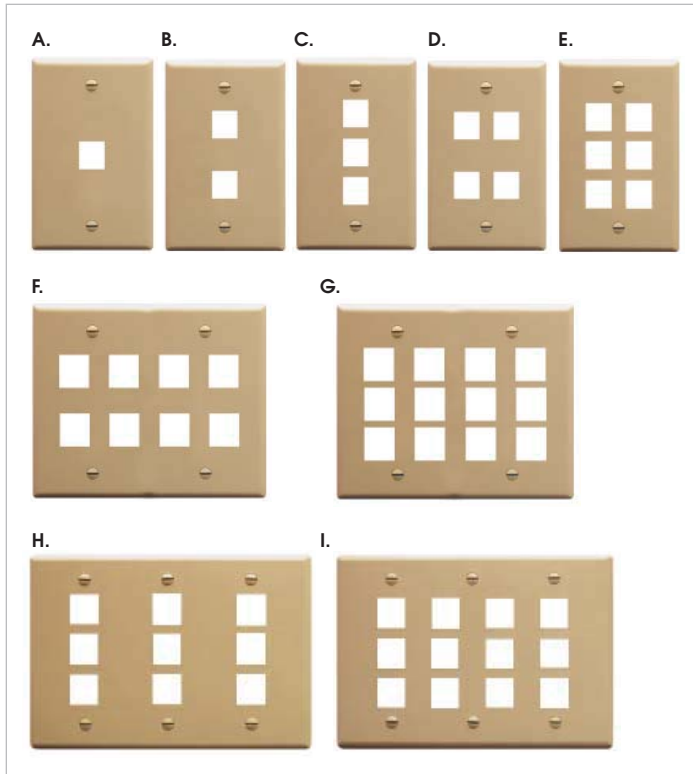

CLASSIC CONFIGURABLE FACEPLATES

- Flush mount style
- Durable ABS plastic

PART NO.	DESCRIPTION	CARTON / CASE
A. IC107F01xx ¹	1-Port, single gang	25 / 200
B. IC107F02xx ¹	2-Ports, single gang	25 / 200
C. IC107F03xx ¹	3-Ports, single gang	25 / 200
D. IC107F04xx ¹	4-Ports, single gang	25 / 200
E. IC107F06xx ¹	6-Ports, single gang	25 / 200
F. IC107FD8xx ¹	8-Ports, double gang	25 / 100
G. IC107F12xx ¹	12-Ports, double gang	25 / 100
H. IC107FT9xx ²	9-Ports, triple gang	25 / 200
I. IC107FT0xx ²	12-Ports, triple gang	25 / 100

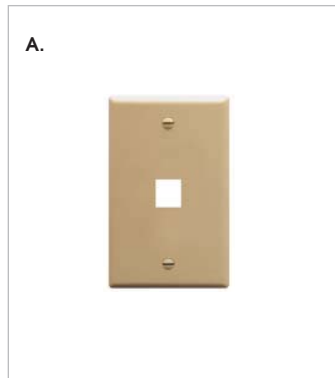

CLASSIC CONFIGURABLE FACEPLATE VALUEPACKS

- Packaged in a resealable box for easy storage
- Reduces packaging waste
- 25 pieces per box

PART NO.	DESCRIPTION
A. IC107F1Cxx ¹	1-Port, single gang, 25 pcs.
IC107F2Cxx ¹	2-Ports, single gang, 25 pcs.
IC107F3Cxx ¹	3-Ports, single gang, 25 pcs.
IC107F4Cxx ¹	4-Ports, single gang, 25 pcs.

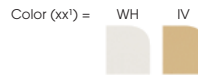

CLASSIC CONFIGURABLE FACEPLATE FEATURES

We offer a wide selection of classic faceplates. They are configurable with modular connectors, couplers and adapters and are designed to fit standard NEMA outlet boxes. Faceplates come in various colors.



Classic: Traditional design

Stainless Steel: Greater durability, easy-to-clean

Angled: Reduces cord bending

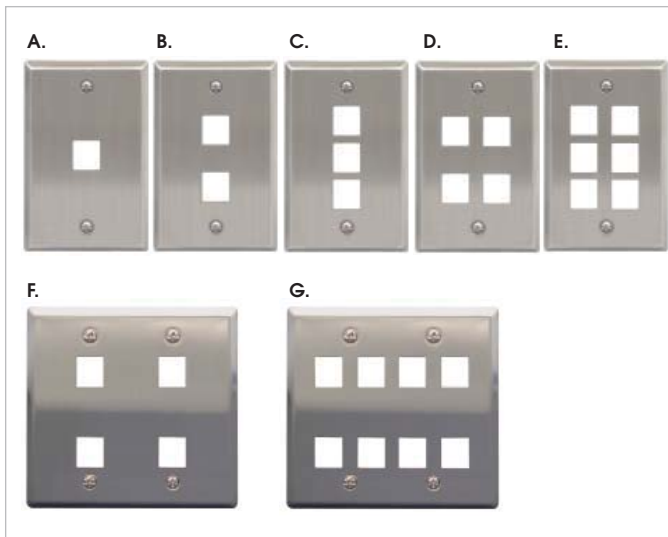

CLASSIC STAINLESS STEEL CONFIGURABLE FACEPLATES

- Flush mount style
- Corrosion resistant 304 stainless steel

PART NO.	DESCRIPTION	CARTON / CASE
A. IC107SF1SS	1-Port, single gang	25 / 200
B. IC107SF2SS	2-Ports, single gang	25 / 200
C. IC107SF3SS	3-Ports, single gang	25 / 200
D. IC107SF4SS	4-Ports, single gang	25 / 200
E. IC107SF6SS	6-Ports, single gang	25 / 200
F. IC107DF4SS	4-Ports, double gang	25 / 100
G. IC107DF8SS	8-Ports, double gang	25 / 100

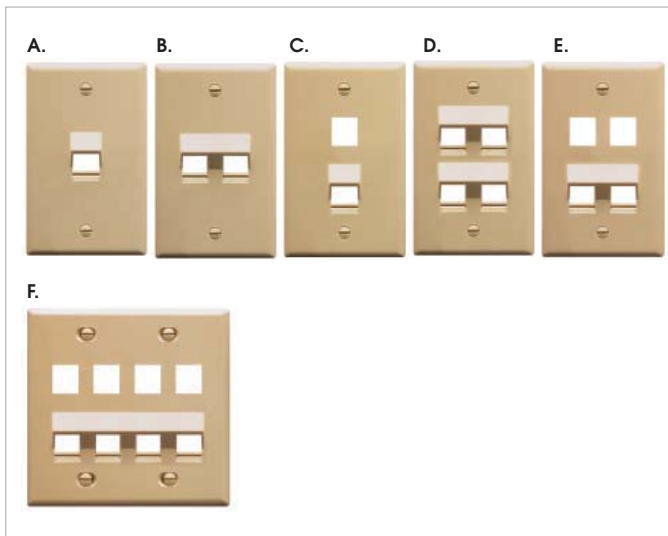

CLASSIC ANGLED CONFIGURABLE FACEPLATES

- Angled ports help reduce cable stress
- Flush mount style
- Durable ABS plastic

PART NO.	DESCRIPTION	CARTON / CASE
A. IC107DA1xx ¹	1-Port angled, single gang	25 / 200
B. IC107DA2xx ¹	2-Ports angled, single gang	25 / 200
C. IC107AF2xx ²	1-Port flat, 1-Port angled, single gang	25 / 200
D. IC107DA4xx ¹	4-Ports angled, single gang	25 / 200
E. IC107AF4xx ²	2-Ports flat, 2-Ports angled, single gang	25 / 200
F. IC107AF8xx ²	4-Ports flat, 4-Ports angled, double gang	25 / 200

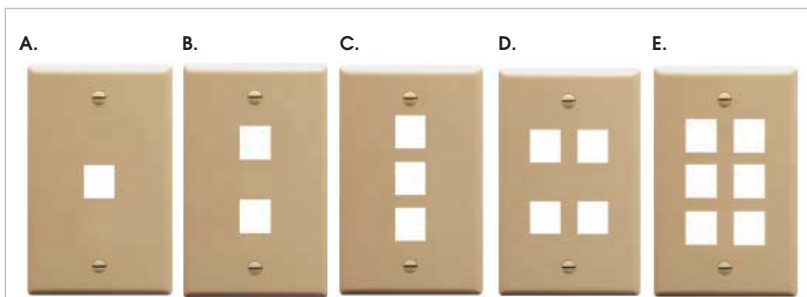

CLASSIC OVERSIZED CONFIGURABLE FACEPLATES

- Designed to cover uneven and oversized drywall cuts
- Larger than standard faceplates
- Flush mount style
- Durable ABS plastic

PART NO.	DESCRIPTION	CARTON / CASE
A. IC107LF1xx ¹	1-Port, single gang	25 / 200
B. IC107LF2xx ¹	2-Ports, single gang	25 / 200
C. IC107LF3xx ¹	3-Ports, single gang	25 / 200
D. IC107LF4xx ¹	4-Ports, single gang	25 / 200
E. IC107LF6xx ¹	6-Ports, single gang	25 / 200

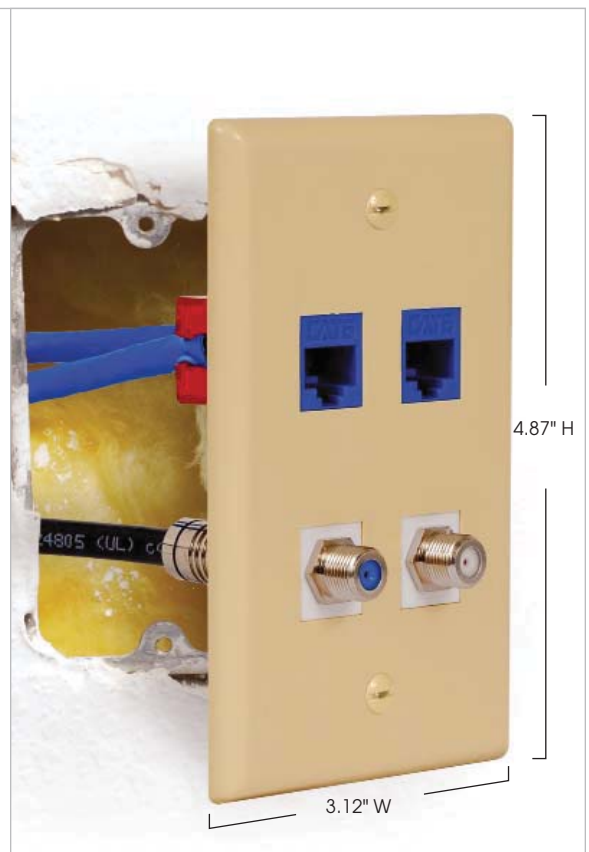

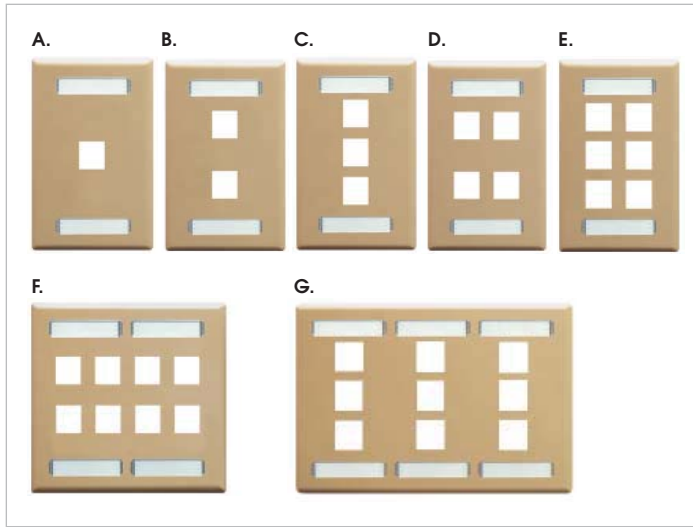

CLASSIC CONFIGURABLE FACEPLATES WITH STATION ID

- Flush mount style
- Durable ABS plastic
- Package includes paper labels and clear view covers

PART NO.	DESCRIPTION	CARTON / CASE
A. IC107S01xx ¹	1-Port, single gang	25 / 200
B. IC107S02xx ¹	2-Ports, single gang	25 / 200
C. IC107S03xx ¹	3-Ports, single gang	25 / 200
D. IC107S04xx ¹	4-Ports, single gang	25 / 200
E. IC107S06xx ¹	6-Ports, single gang	25 / 200
F. IC107SD8xx ¹	8-Ports, double gang	25 / 100
G. IC107ST9xx ¹	9-Ports, triple gang	25 / 100

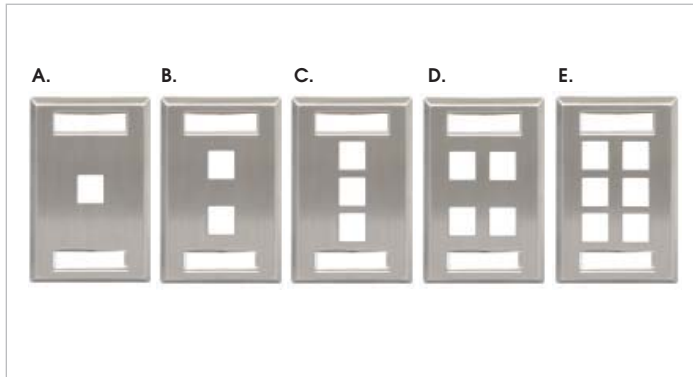
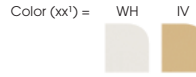

CLASSIC STAINLESS STEEL CONFIGURABLE FACEPLATES WITH STATION ID

- Flush mount style
- Corrosion resistant 304 stainless steel
- Package includes paper labels and clear view covers

PART NO.	DESCRIPTION	CARTON / CASE
A. IC107S01SS	1-Port, single gang	25 / 200
B. IC107S02SS	2-Ports, single gang	25 / 200
C. IC107S03SS	3-Ports, single gang	25 / 200
D. IC107S04SS	4-Ports, single gang	25 / 200
E. IC107S06SS	6-Ports, single gang	25 / 200

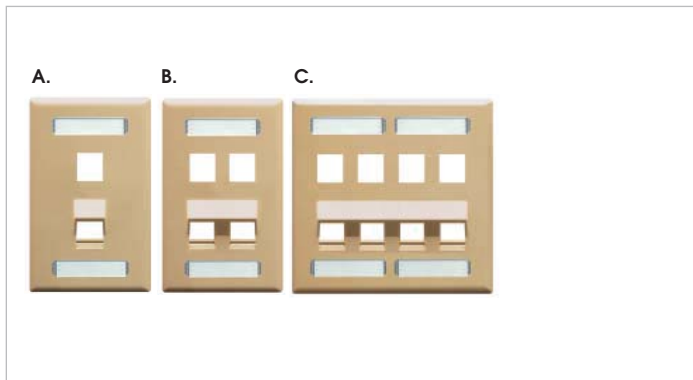

CLASSIC ANGLED CONFIGURABLE FACEPLATES WITH STATION ID

- Angled ports help reduce cable stress
- Flush mount style
- Durable ABS plastic
- Package includes paper labels and clear view covers

PART NO.	DESCRIPTION	CARTON / CASE
A. IC107AS2xx ¹	1-Port flat, 1-Port angled, single gang	25 / 200
B. IC107AS4xx ¹	2-Ports flat, 2-Ports angled, single gang	25 / 200
C. IC107AS8xx ¹	4-Ports flat, 4-Ports angled, double gang	25 / 200

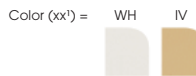

THREE STYLES OF CONFIGURABLE FACEPLATES



Accept labels up to 1.70" W x 0.40" H



HDMI Décorex™ Inserts



Station ID

Décorex

Electrical

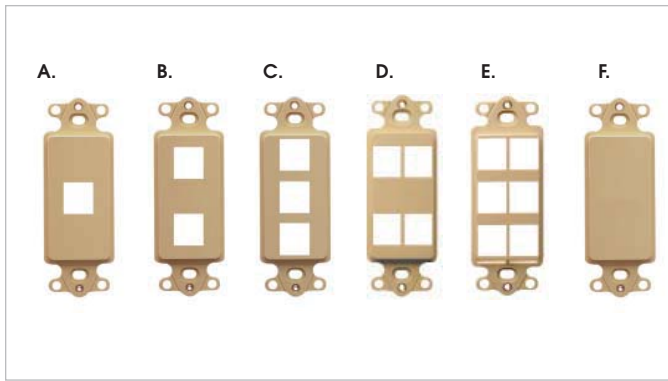

DÉCOREX™ CONFIGURABLE INSERTS

- Inserts are configurable with modular connectors
- Durable ABS plastic

PART NO.	DESCRIPTION	CARTON / CASE
A. IC107DI1xx ¹	1-Port	50 / 400
B. IC107DI2xx ¹	2-Ports	50 / 400
C. IC107DI3xx ¹	3-Ports	50 / 400
D. IC107DI4xx ¹	4-Ports; works with HD style connectors only	50 / 400
E. IC107DI6xx ¹	6-Ports; works with HD style connectors only	50 / 400
F. IC630DIBxx ²	Blank insert	50 / 400

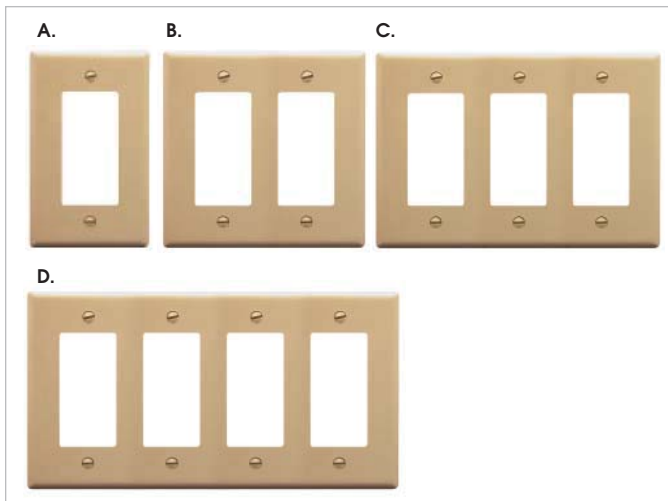

DÉCOREX CONFIGURABLE FACEPLATES

- Faceplates are configurable with Décorex inserts
- Durable ABS plastic

PART NO.	DESCRIPTION	CARTON / CASE
A. IC107DFSxx ¹	1-Insert space, single gang	25 / 200
B. IC107DFDxx ¹	2-Insert spaces, double gang	25 / 200
C. IC107DFTxx ¹	3-Insert spaces, triple gang	50 / 200
D. IC107DFQxx ¹	4-Insert spaces, quad gang	25 / 100



DÉCOREX STAINLESS STEEL CONFIGURABLE FACEPLATES

- Faceplates are configurable with Décorex inserts
- Corrosion resistant 304 stainless steel

PART NO.	DESCRIPTION	CARTON / CASE
A. IC107DFSSS	1-Insert space, single gang	25 / 100
B. IC107DFDSS	2-Insert spaces, double gang	25 / 100

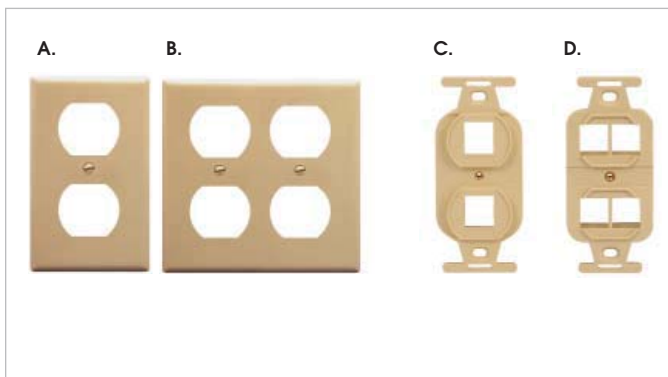

ELECTRICAL CONFIGURABLE FACEPLATES & INSERTS

- Durable ABS plastic
- Faceplates are configurable with electrical inserts
- Inserts are configurable with modular connectors

PART NO.	DESCRIPTION	CARTON / CASE
A. IC106FP2xx ¹	2-Ports, single gang faceplate	25 / 500
B. IC106FP4xx ²	4-Ports, double gang faceplate	25 / 250
C. IC107DPIxx ¹	2-Ports, insert	50 / 400
D. IC1074PIxx ¹	4-Ports, insert; works with HD style connectors only	50 / 400

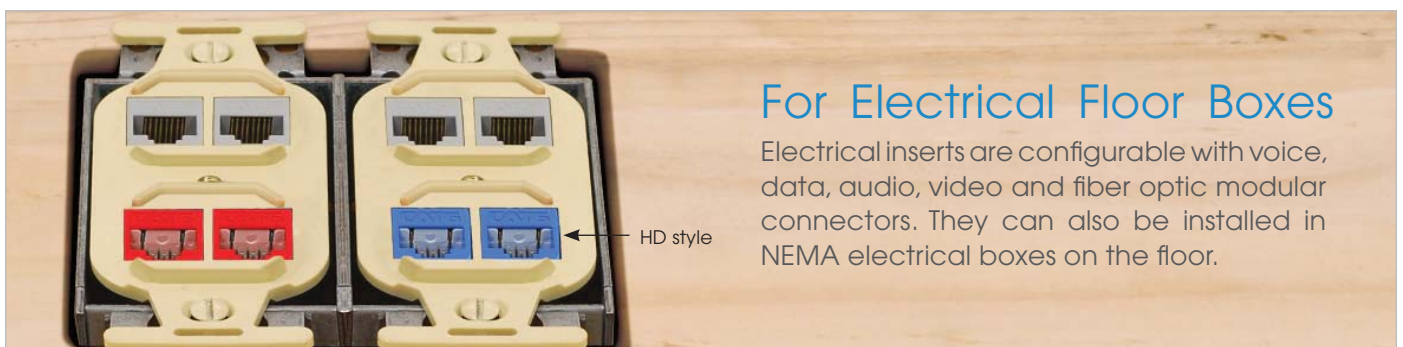

For Electrical Floor Boxes

Electrical inserts are configurable with voice, data, audio, video and fiber optic modular connectors. They can also be installed in NEMA electrical boxes on the floor.



FLUSH CONFIGURABLE TELEPHONE WALL PLATES

- Designed with standoffs to mount phones on walls and vertical surfaces
- Flush mount style

PART NO.	DESCRIPTION	CARTON / CASE
A. IC107FFWSS	1-Port, single gang, stainless steel	25 / 200
B. IC107FFWxx¹	1-Port, single gang, ABS plastic	25 / 200



RECESSED CONFIGURABLE TELEPHONE WALL PLATES

- Designed with standoffs to mount phones on walls and vertical surfaces
- Recessed style
- Use color ID caps for a clean appearance

PART NO.	DESCRIPTION	CARTON / CASE
A. IC107FRWSS	1-Port, single gang, stainless steel	25 / 200
B. IC107FRWxx¹	1-Port, single gang, ABS plastic	25 / 200



RECESSED CONFIGURABLE TELEPHONE WALL PLATES

- Designed with standoffs to mount phones on walls and vertical surfaces
- Recessed style
- Durable ABS plastic
- Use color ID caps for a clean appearance

PART NO.	DESCRIPTION	CARTON / CASE
IC107FWPxx¹	1-Port, single gang	25 / 200

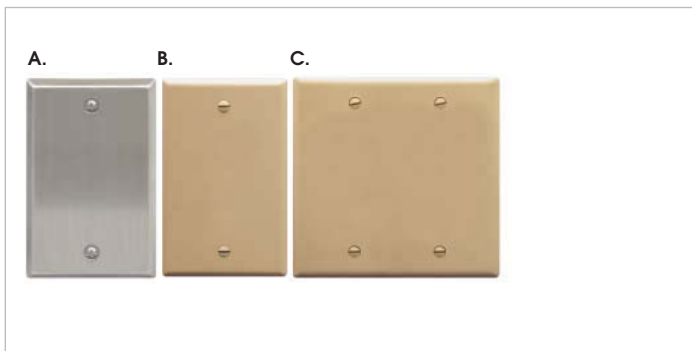

BLANK FACEPLATES

- Covers open and unused wall outlets until needed

PART NO.	DESCRIPTION	CARTON / CASE
A. IC630EBSS	Blank, single gang, stainless steel	25 / 200
B. IC630EB0xx¹	Blank, single gang, ABS plastic	25 / 200
C. IC630EBDxx¹	Blank, double gang, ABS plastic	25 / 100



Blank Faceplates

WORK AREA OUTLETS



BULK NOSE FACEPLATES

- Faceplates are molded with large opening
- Allows bulky cable to pass through the wall outlet
- Durable ABS plastic

PART NO. **DESCRIPTION**
A. IC640BSSxx¹ Single gang
 • 1.25" W x 0.90" D opening

CARTON / CASE
 15 / 120

B. IC640BDSxx¹ Double gang
 • 2.75" W x 1.15" D opening

10 / 80

Color (xx¹) = WH IV

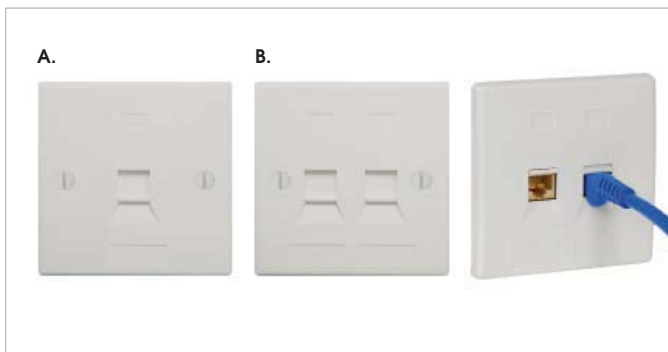

INTERNATIONAL CONFIGURABLE FACEPLATES

- Works with international wall outlet dimensions
- Spring loaded shutters in ports, prevent dust from entering
- Recessed areas above and below ports for easy labeling

PART NO. **DESCRIPTION**
A. IC107EF1WH 1-Port, 86 mm H x 86 mm W
B. IC107EF2WH 2-Ports, 86 mm H x 86 mm W

CARTON / CASE
 25 / 200
 25 / 200

Color = White



EURO STYLE CONFIGURABLE ELITE™ MULTIMEDIA BOXES

- Works with international European wall outlet dimensions
- Two-piece design, faceplate and mounting box
- Configurable with Elite bezels
- Box is designed with knockouts to work with raceway systems
- Package includes paper labels, clear view covers and mounting screws

PART NO. **DESCRIPTION**
IC108CE1xx¹ 1-Bezel opening, 83.5 mm H x 83.5 mm W x 55.626 mm D

Color (xx¹) = WH IV GY

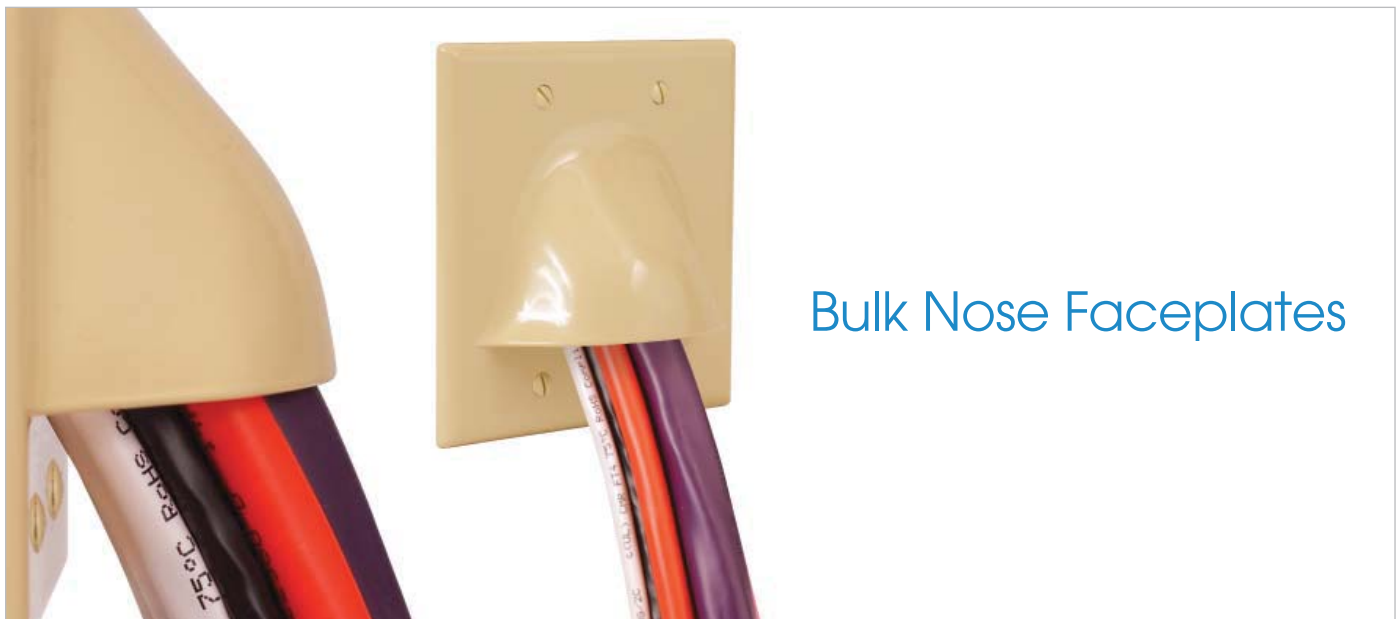

Bulk Nose Faceplates

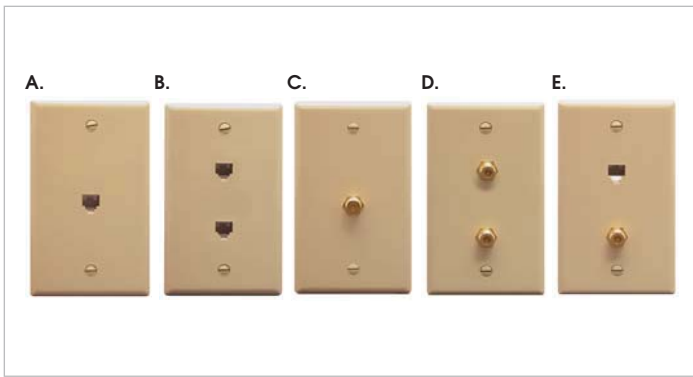

WALL PLATES INTEGRATED WITH VOICE AND VIDEO

- One-piece design; no assembly required
- Designed with rear Phillips screw down terminals
- Durable ABS plastic

PART NO.	DESCRIPTION	CARTON / CASE
A. IC630E60xx ¹	6P6C, single gang	25 / 200
B. IC630E66xx ¹	2 6P6C, single gang	25 / 200
C. IC630EG0xx ¹	F-Type, single gang	25 / 200
D. IC630EGGxx ¹	2 F-Type, single gang	25 / 200
E. IC630E6Gxx ¹	6P6C and F-Type, single gang	25 / 200

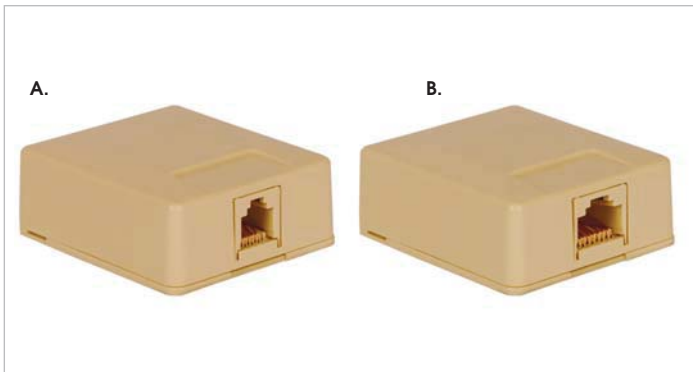
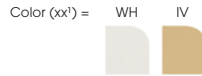

SURFACE MOUNT JACKS INTEGRATED WITH VOICE

- Two-piece design; cover and base
- Wiring diagram is molded under the cover
- Designed with rear Phillips screw down terminals
- Package includes adhesive strips and wood screws for mounting

PART NO.	DESCRIPTION	CARTON / CASE
A. IC625SB6xx ¹	6P6C	100 / 400
B. IC625SB8xx ¹	8P8C	100 / 400

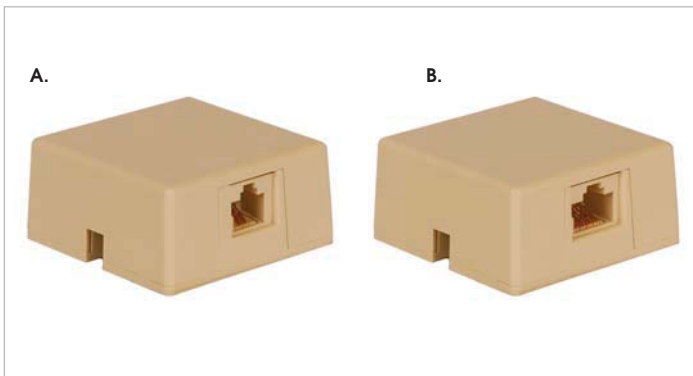
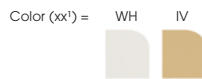

SURFACE MOUNT JACKS INTEGRATED WITH VOICE

- Two-piece design; cover and base
- Wiring diagram is molded under the cover
- Designed with a keyed RJ31X jack with shorting bar
- Designed with rear Phillips screw down terminals
- Package includes adhesive strips and wood screws for mounting

PART NO.	DESCRIPTION	CARTON / CASE
A. IC635DS4xx ¹	8P4C	75 / 300
B. IC635DS8xx ¹	8P8C	75 / 300

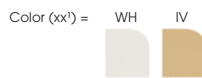

SCREW DOWN TERMINATION FEATURES

Wall plates, surface mount jacks and Décorex™ inserts are designed with deep slotted Phillips screw heads to provide a traditional way to terminate wires.



Deep slotted and flat Phillips screws will not slip when using automatic screw drivers

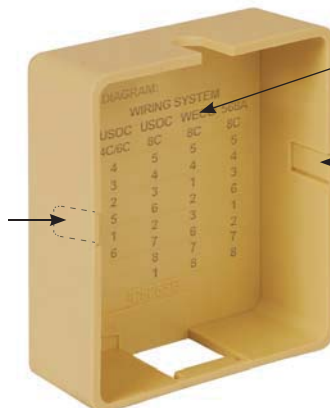

Wiring diagram is molded under the cover



Removable side knockouts

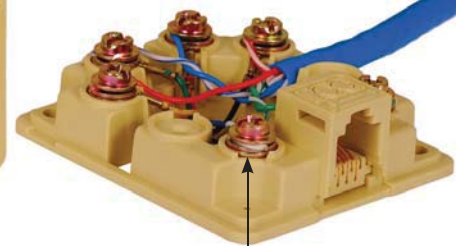

Double washers so wires will not unwind

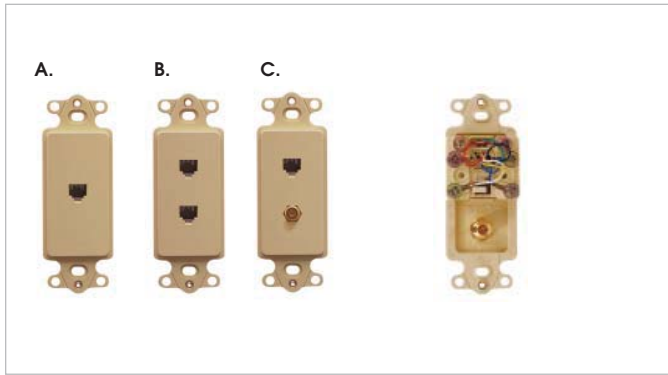

DECOREX INSERTS INTEGRATED WITH VOICE AND VIDEO

- Designed with rear Phillips screw down terminals
- Durable ABS plastic

PART NO.	DESCRIPTION	CARTON / CASE
A. IC630DI6xx ¹	6P6C	25 / 200
B. IC630DD6xx ¹	2 6P6C	50 / 400
C. IC630DVFxx ¹	6P6C and F-Type	25 / 200



TELEPHONE WALL PLATES INTEGRATED WITH VOICE

- Designed with standoffs to mount phones on walls and vertical surfaces
- Designed with rear Phillips screw down terminals
- Durable ABS plastic

PART NO.	DESCRIPTION	CARTON / CASE
IC630DB6xx ¹	6P6C, single gang	25 / 200

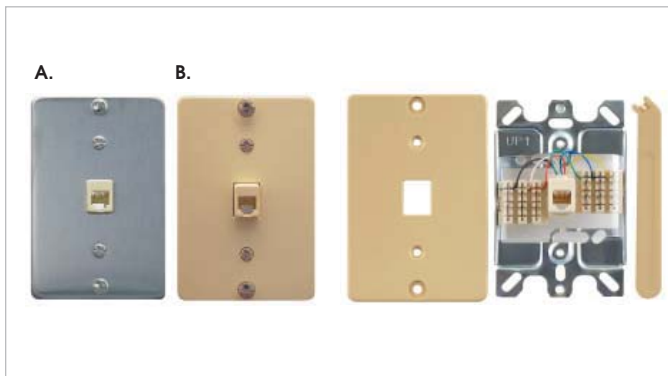
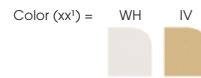

TELEPHONE WALL PLATES INTEGRATED WITH VOICE

- Designed with standoffs to mount phones on walls and vertical surfaces
- Designed with rear 110-Type IDC for fast termination
- Package includes 110 punch-down termination tool

PART NO.	DESCRIPTION	CARTON / CASE
A. IC630DA6SS	6P6C, single gang, stainless steel	25 / 200
B. IC630SS6xx ¹	6P6C, single gang, ABS plastic	25 / 200

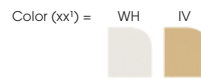

Telephone Wall Plates
Designed with mounting standoffs so phones can be hung securely on the wall.

Page **22** and **25**

CONFIGURABLE HIGH DENSITY NEMA MODULAR FURNITURE FACEPLATES

- Fits in office furniture with NEMA size openings
- Faceplates are configurable with HD style connectors only

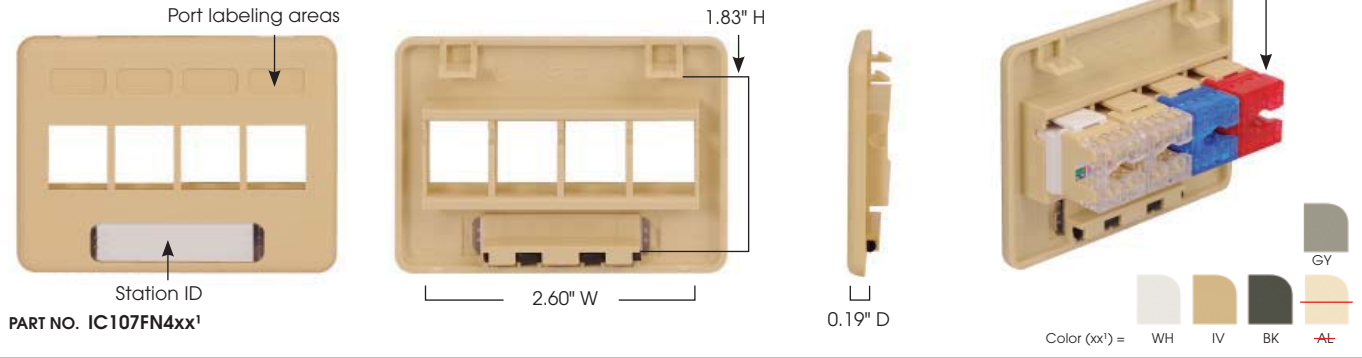

CONFIGURABLE HIGH DENSITY TIA MODULAR FURNITURE FACEPLATES

- Fits in office furniture with TIA size openings
- Faceplates are configurable with HD style connectors only

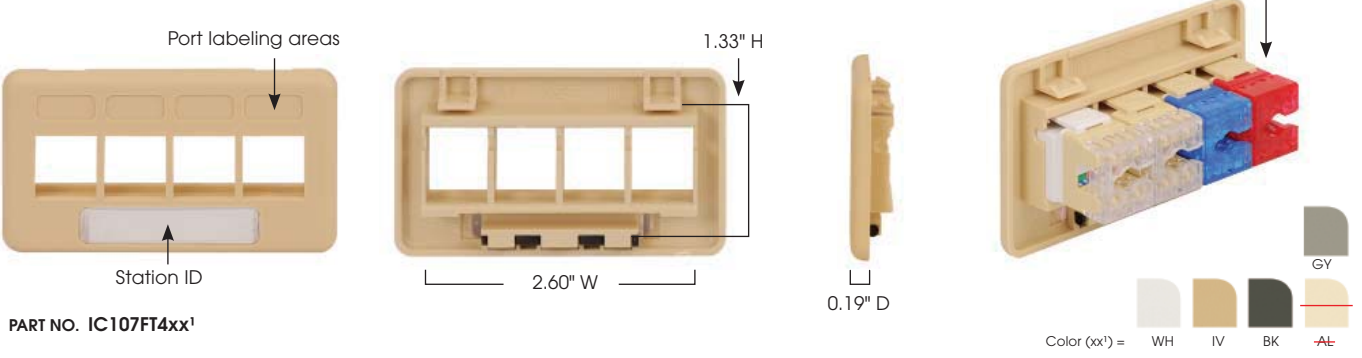

CONFIGURABLE MODULAR FURNITURE FACEPLATES

- Fits in office furniture with TIA size openings
- Faceplates are configurable with EZ[®] and HD style connectors

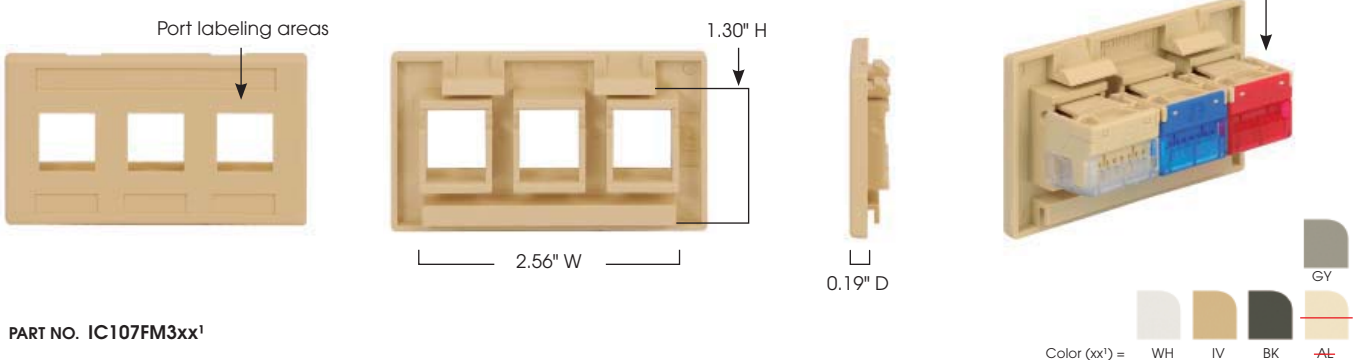

CONFIGURABLE UNIVERSAL MODULAR FURNITURE FACEPLATES WITH ADJUSTABLE LOCKING TABS

- Two-piece design, faceplate and mounting box
- Faceplates are configurable with EZ[®] and HD style connectors
- Package includes wood screws for mounting

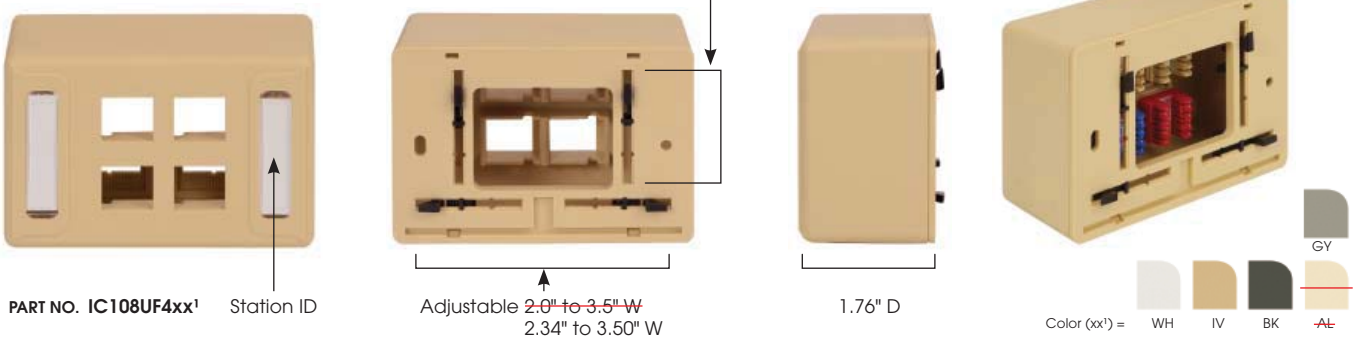

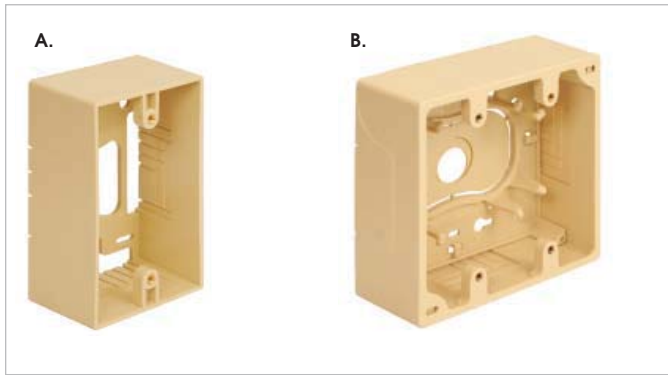

MOUNTING BOXES

- Durable ABS plastic
- Package includes adhesive strips and wood screws for mounting
- Package includes cable ties for cable management

PART NO.	DESCRIPTION
A. IC107MRSxx ¹	Single gang, 4.5" H x 2.75" W x 1.89" D
B. IC107MRDxx ¹	Double gang, 4.5" H x 4.6" W x 1.89" D

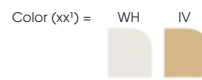

LOW-PROFILE MOUNTING BOXES

- Works with wall plates and Décorex inserts with screw-down terminals only
- Durable ABS plastic
- Package includes wood screws for mounting

PART NO.	DESCRIPTION
IC250MBSxx ¹	Single gang, 4.5" H x 2.75" W x 0.93" D

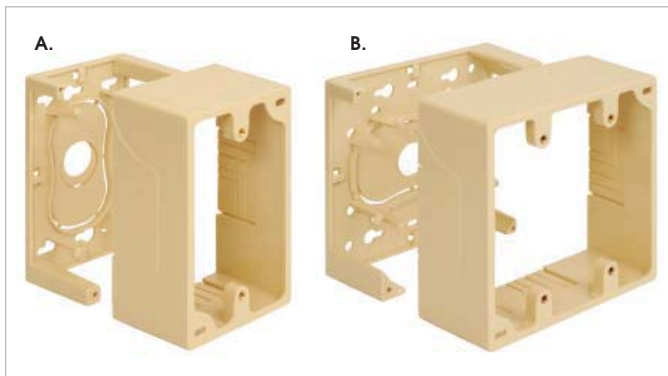
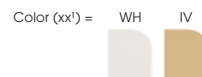

JUNCTION BOXES

- Two-piece design; mounting box and base
- Durable ABS plastic
- Package includes adhesive strips and wood screws for mounting
- Package includes cable ties for cable management

PART NO.	DESCRIPTION
A. ICACSMBSxx ¹	Single gang, 4.5" H x 2.75" W x 1.89" D
B. ICACSMBDxx ¹	Double gang, 4.5" H x 4.6" W x 1.89" D

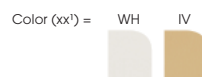

MOUNTING AND JUNCTION BOX FEATURES

Mounting and junction boxes fit standard NEMA outlet boxes. They work with single and double gang faceplates. Designed with routing posts, cable tie points and knockouts to work with raceway systems.

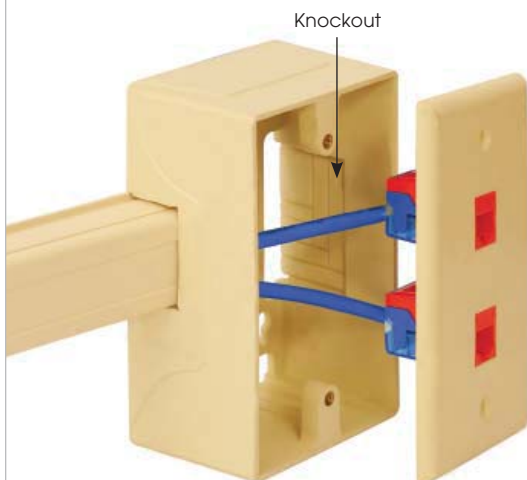

Mounting boxes: Cables need to be pulled through the box prior to mounting.

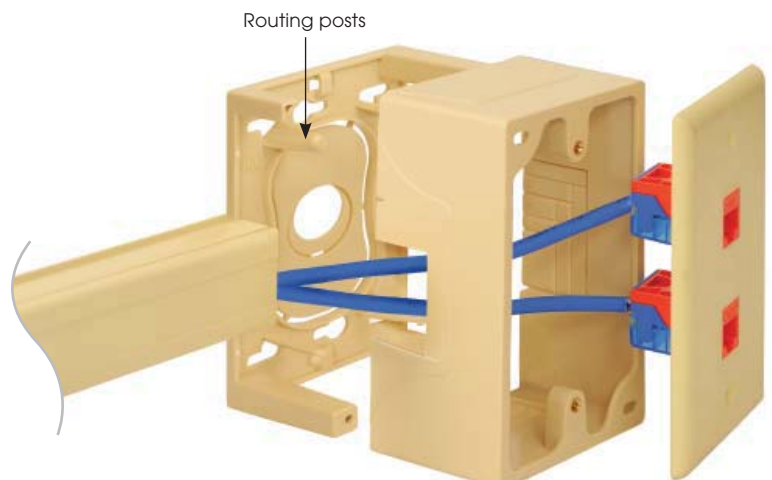

Junction boxes: Bases and raceway can be mounted prior to cable pulling.

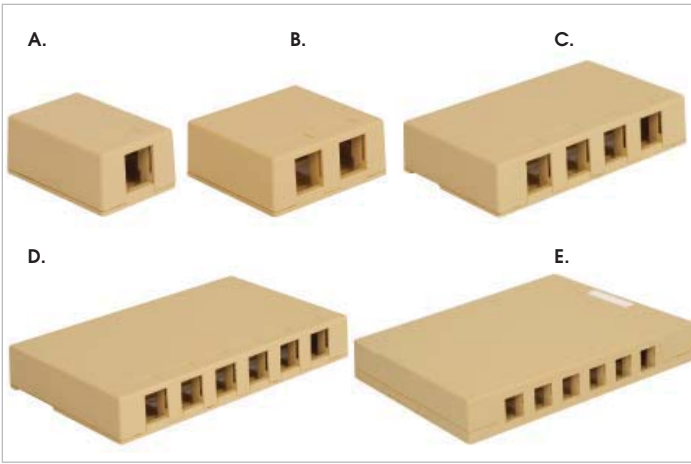

CLASSIC CONFIGURABLE SURFACE MOUNT BOXES

- Two-piece design; cover and base
- Durable ABS plastic
- Package includes adhesive strips and wood screws for mounting

PART NO.	DESCRIPTION
A. IC107SB1xx ¹	1-Port
B. IC107SB2xx ¹	2-Ports
C. IC107SB4xx ²	4-Ports
D. IC107SB6xx ²	6-Ports
E. IC107SBTxx ²	12-Ports, 1 station ID, works with raceway and magnets

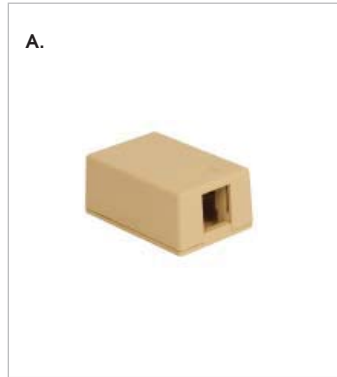

CLASSIC CONFIGURABLE SURFACE MOUNT BOX VALUEPACKS

- Packaged in a resealable box for easy storage
- Reduces packaging waste
- 25 pieces per box

PART NO.	DESCRIPTION
A. IC107BC1xx ¹	1-Port, 25 pcs.
IC107BC2xx ¹	2-Ports, 25 pcs.

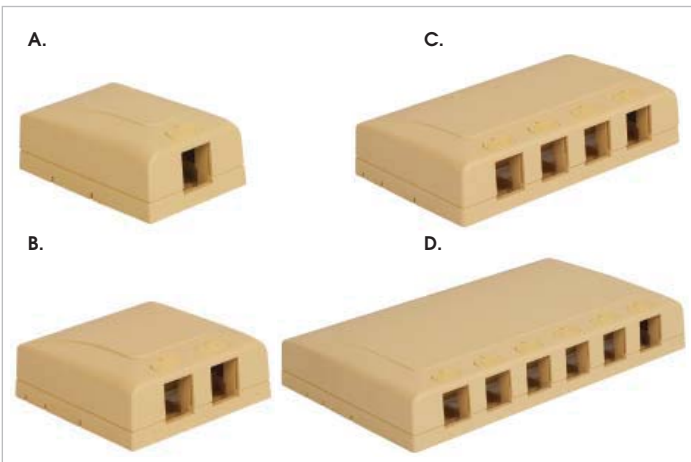
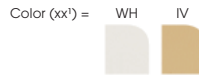

ELITE™ CONFIGURABLE SURFACE MOUNT BOXES

- Two-piece design; cover and base
- Designed to work with raceway and magnets
- Durable ABS plastic
- Package includes adhesive strips and wood screws for mounting
- Package includes icons

PART NO.	DESCRIPTION
A. IC108SB1xx ¹	1-Port
B. IC108SB2xx ¹	2-Ports
C. IC108SB4xx ¹	4-Ports, includes cable ties
D. IC108SB6xx ¹	6-Ports, includes cable ties



SURFACE MOUNT BOX FEATURES

Classic and Elite™ surface mount boxes are configurable with HD and EZ® style modular connectors.

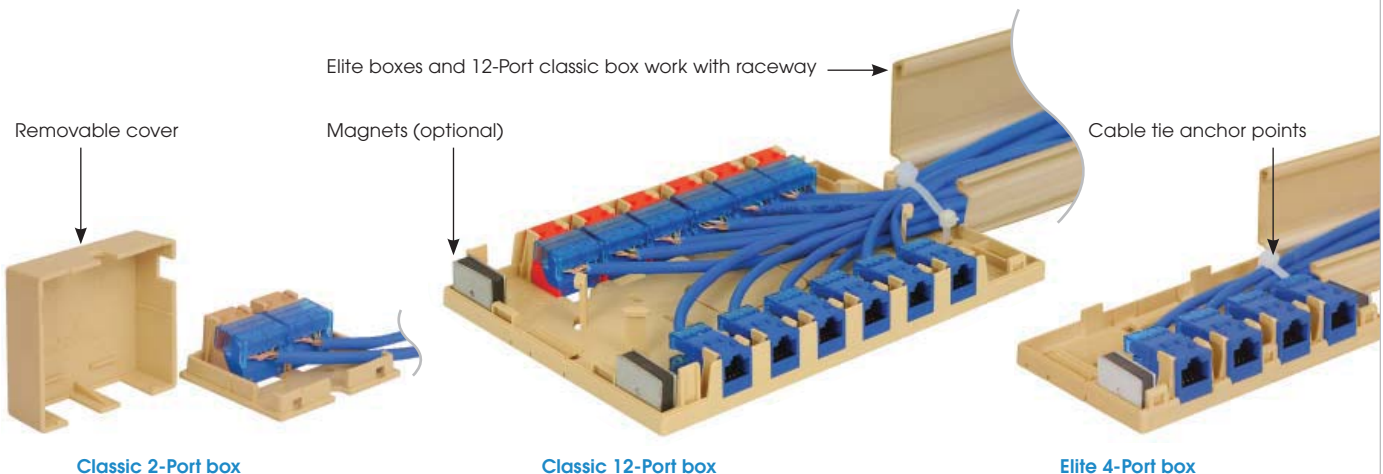

Classic 2-Port box

Classic 12-Port box

Elite 4-Port box



6-PORT CAT 6 AND CAT 5e MOBILE PATCH BOXES

- Two-piece design; cover and base
- Designed with rear 110-Type IDC for fast termination
- 50 micro-inch gold plated contacts
- Exceeds TIA-568 CAT 6 and CAT 5e performance standards
- Package includes wood screws for mounting
- Package includes cable ties for cable management
- Durable ABS plastic

PART NO.	DESCRIPTION
A. ICMPPMB606	CAT 6, 8P8C, 6-Ports
B. ICMPPMB506	CAT 5e, 8P8C, 6-Ports



6-PORT CONFIGURABLE MOBILE PATCH BOX

- Two-piece design; cover and base
- Box is configurable with modular connectors
- Package includes wood screws for mounting
- Package includes cable ties for cable management
- Durable ABS plastic

PART NO.	DESCRIPTION
IC107MB6BK	6-Ports blank

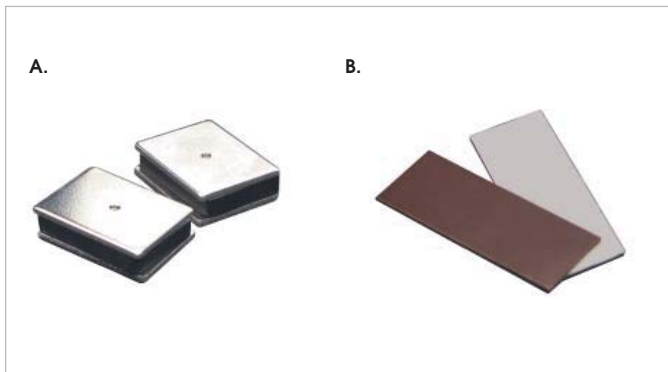

METAL AND ADHESIVE MAGNETS

- To mount boxes on flat metal surfaces

PART NO.	DESCRIPTION
A. ICMAGBLOCK	Metal magnet, 2 pcs.
B. IC317MTAPE	Adhesive magnet, 2 pcs.

- Works with boxes designed with magnet holders
- Magnetic front with rear adhesive tape
- Works with all boxes

MOBILE PATCH BOX FEATURES

Mobile patch boxes allow connectivity in open environments where outlet is unavailable. Use for temporary workstations, POS terminals, warehouses, industrial environment, tradeshows, retail showrooms and more.

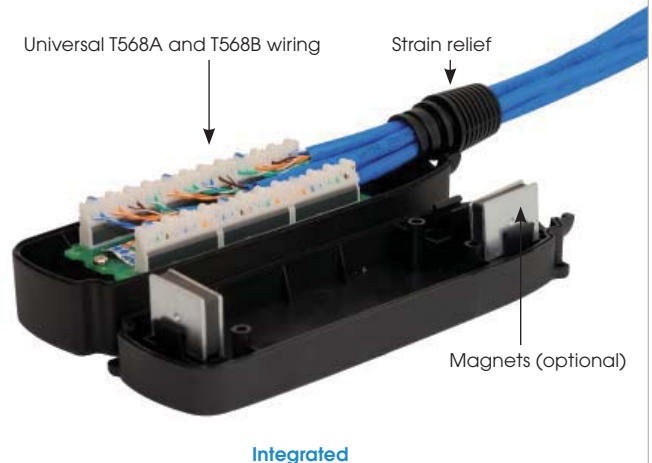
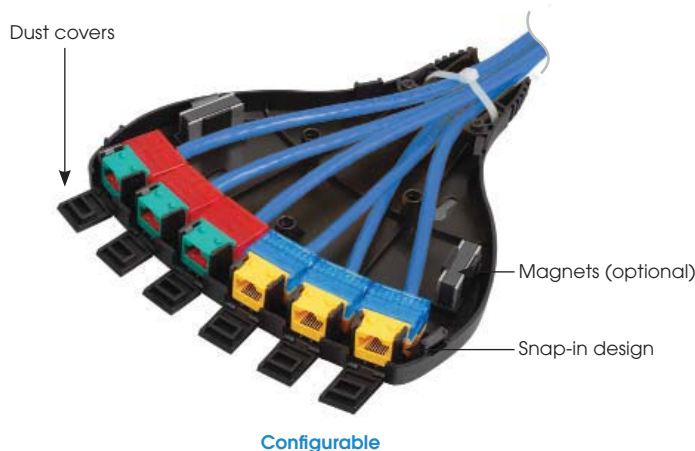

FLAT AND ANGLED ELITE™ BEZELS

- Install bezels in Elite™ series faceplates, outlets and MUTOA boxes
- Package includes icons

Color (xx') = WH IV



PART NO.	IC108BF1xx¹	IC108BF2xx¹	IC108BA1xx¹	IC108BA2xx¹	IC108BFBxx¹
DESCRIPTION	1-Port, flat	2-Ports, flat	1-Port, angled	2-Ports, angled	Blank, flat

SINGLE AND DOUBLE GANG ELITE™ FACEPLATES WITH STATION ID

Color (xx') = WH IV



← Configurable with Elite™ bezels

PART NO.	IC108F01xx¹	IC108F02xx¹	IC108FD4xx¹
DESCRIPTION	1-Bezel opening	2-Bezel openings	4-Bezel openings

MULTI-USER TELECOMMUNICATIONS OUTLET ASSEMBLY (MUTOA) ELITE™ MULTIMEDIA BOXES

Package includes:

- Cover and base
- Cable ties for cable management
- Paper labels and clear view covers
- Adhesive strips and wood screws for mounting

Color (xx') = WH IV GY

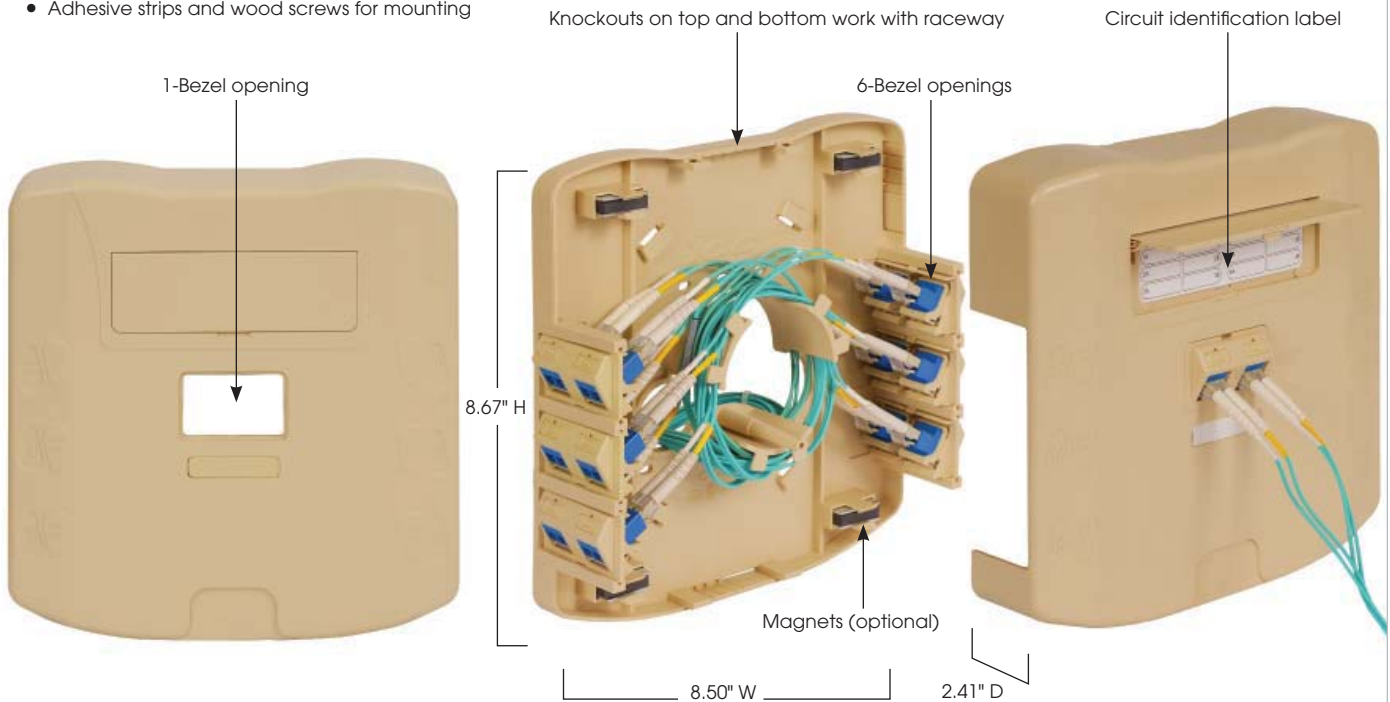

PART NO.	IC108MMBxx¹
DESCRIPTION	MUTOA multimedia box with 7 Elite bezel openings

SINGLE GANG ELITE™ MULTIMEDIA OUTLETS

Color (xx') = WH IV GY

Package includes:

- Cover and base
- Cable ties for cable management
- Paper labels and clear view covers
- Wood screws for mounting

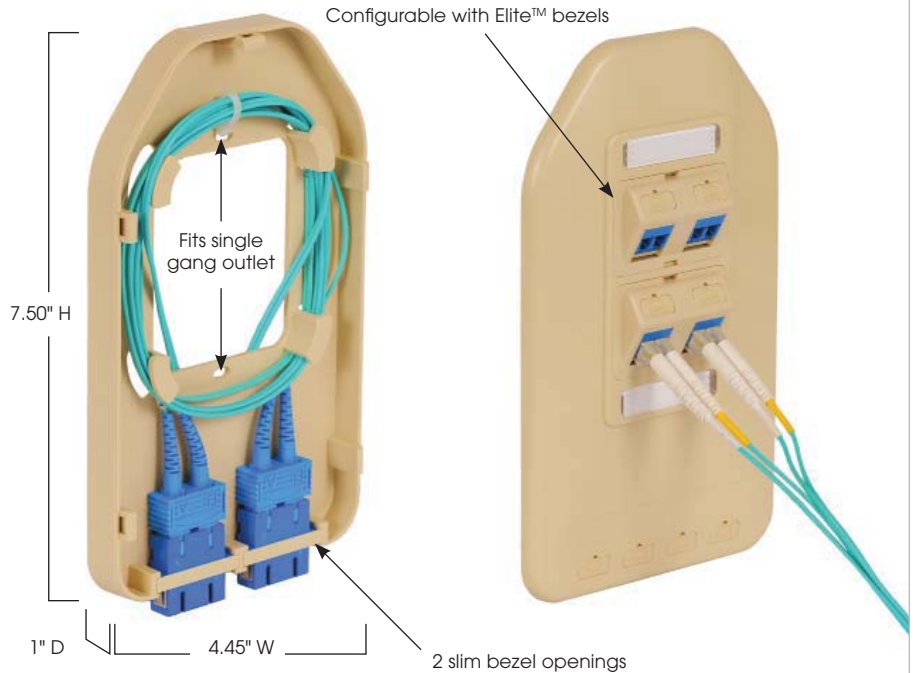
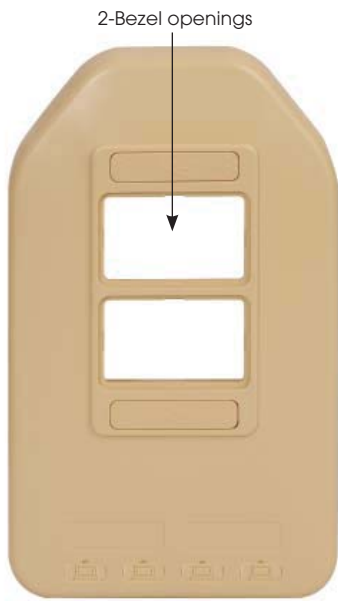

PART NO. IC108WBSxx'
DESCRIPTION Single gang multimedia outlet with 2 Elite and 2 slim bezel openings

DOUBLE GANG ELITE™ MULTIMEDIA OUTLETS

Color (xx') = WH IV GY

Package includes:

- Cover and base
- Cable ties for cable management
- Paper labels and clear view covers
- Wood screws for mounting

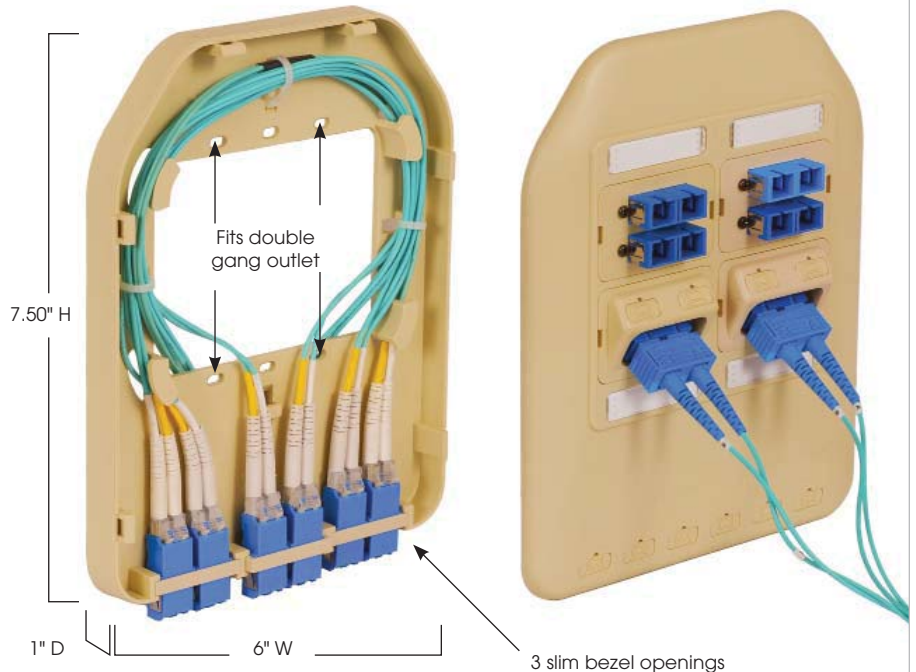
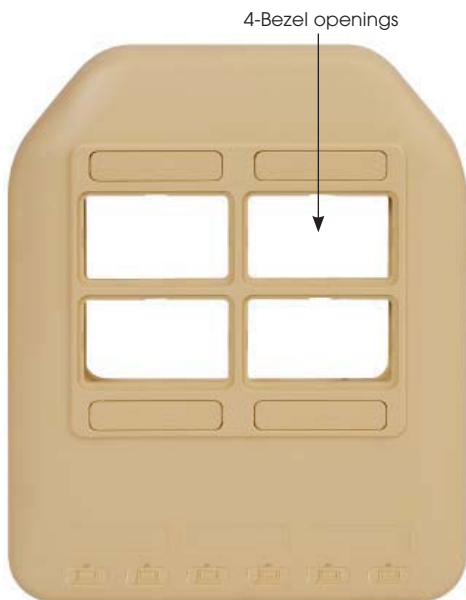

PART NO. IC108WBDxx'
DESCRIPTION Double gang multimedia outlet with 4 Elite and 3 slim bezel openings

CAT 6A 10G UNSHIELDED TWISTED PAIR (UTP) PATCH PANEL

- Permanent Link performance tested up to 7.3dB headroom at 500 MHz
- Panel comes with 24 CAT 6A UTP HD style black modular connectors
- 50 micro-inch gold plated contacts
- Fits standard 19" EIA rack mount widths
- Package includes cable management bar, cable ties and #12 rack screws

PART NO.	DESCRIPTION
ICMPP246AU	24-Port CAT 6A UTP patch panel, 1 RMS*



PERMANENT LINK PERFORMANCE TEST

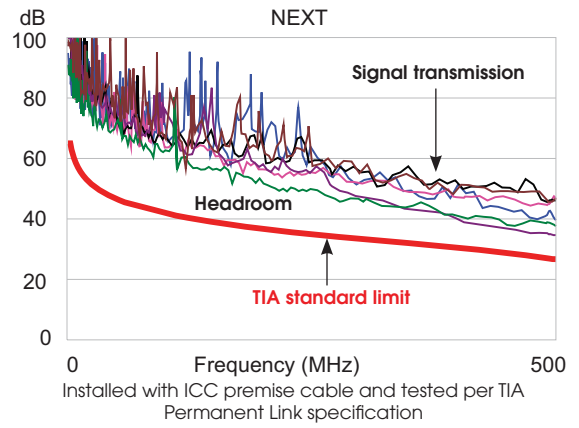

CAT 6A 10G FOILED TWISTED PAIR (FTP) PATCH PANEL

- Permanent Link performance tested up to 2.8dB headroom at 500 MHz
- FTP provides excellent protection against EMI/RFI interferences
- Panel comes with 24 CAT 6A FTP HD style modular connectors
- 50 micro-inch gold plated contacts
- Pre-installed grounding studs
- Fits standard 19" EIA rack mount widths
- Package includes cable management bar, cable ties and #12 rack screws

PART NO.	DESCRIPTION
ICMPP246AS	24-Port CAT 6A FTP patch panel, 1 RMS*



PERMANENT LINK PERFORMANCE TEST

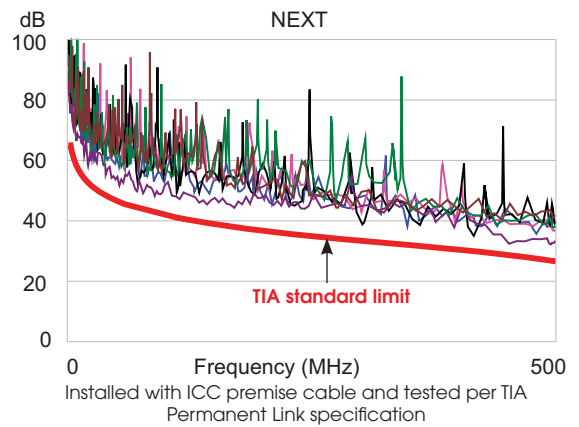

*1 RMS (rack mount space) = 1.75" H

HORIZONTAL PATCH PANEL FEATURES

- Exceeds TIA-568 performance standards
- Built-in PCB technology for maximum signal quality
- 50 micro-inch gold plated contacts

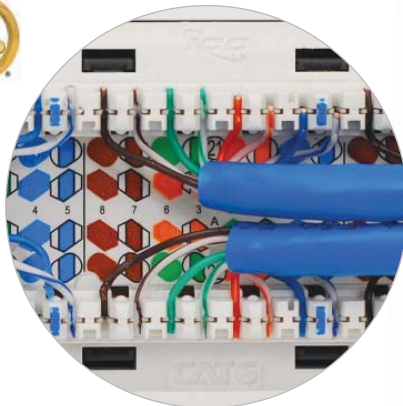

Color wiring diagram makes termination fast and easy

4-Pair punch-down tool →

Nylon cable ties

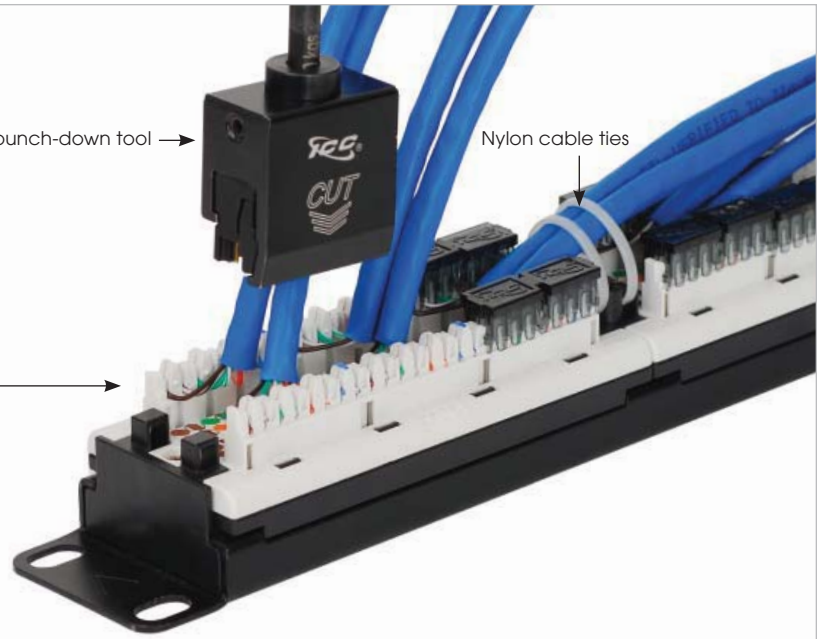

VERTICAL ZERO-U PATCH PANEL FEATURES

- Designed to mount on walls and distribution racks, uses no rack space
- Exceeds TIA-568 performance standards
- Built-in PCB technology for maximum signal quality
- 50 micro-inch gold plated contacts

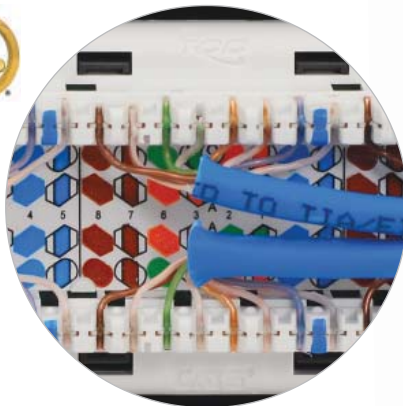

Rear 110-Type IDC

Retention caps
Purchased separately

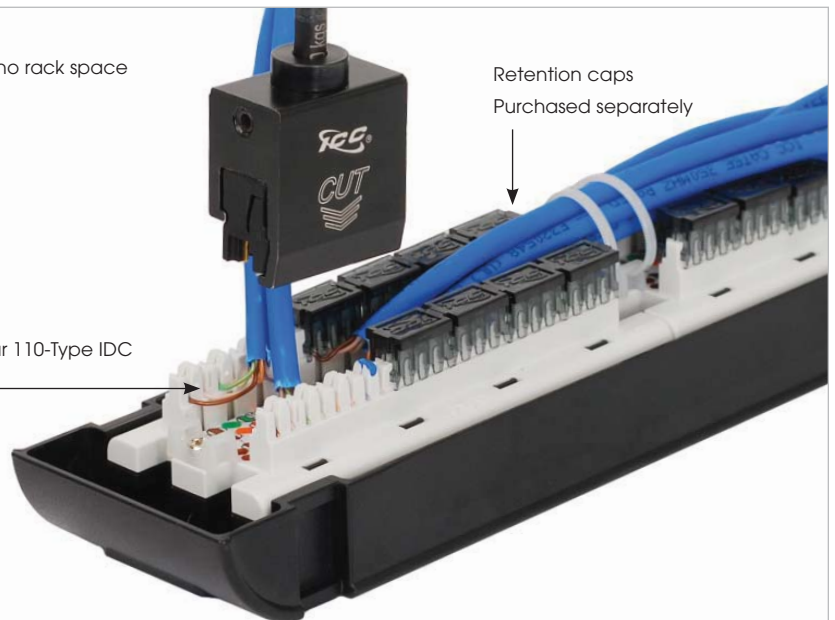

FRONT ACCESS ZERO-U PATCH PANEL FEATURES

- Designed to mount on walls and distribution racks, uses no rack space
- Exceeds TIA-568 performance standards
- Front access 110-Type IDC terminations
- 50 micro-inch gold plated contacts
- Designed for wall mount
- Removable cover

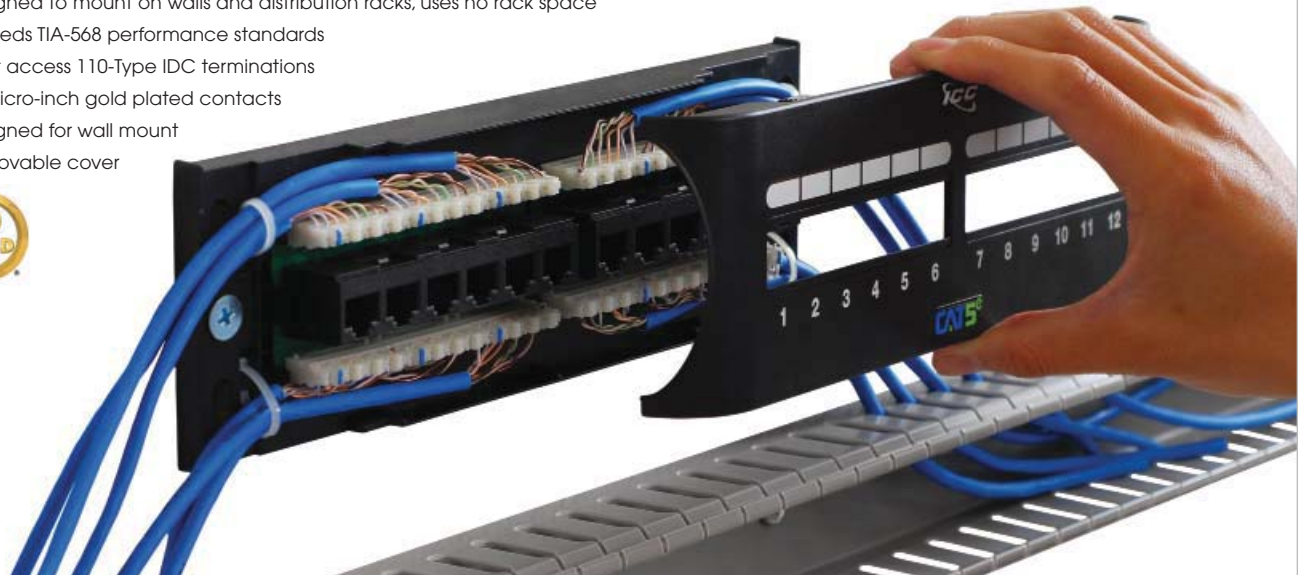



CAT 6 AND CAT 5e 12-PORT VERTICAL ZERO-U PATCH PANELS

- Two-piece design; patch panel with 89D mounting bracket
- Designed to mount on walls and distribution racks, uses no rack space
- 10" H x 3.30" W x 2.40" D
- Package includes cable ties for cable management

PART NO.	DESCRIPTION	CARTON
ICMPP12V60	CAT 6, 12-Ports, 8P8C	25
ICMPP12V5E	CAT 5e, 12-Ports, 8P8C	25



CAT 6 AND CAT 5e 24-PORT PATCH PANEL

- Fits standard 19" EIA rack mount widths
- Package includes cable ties and #12 rack screws

PART NO.	DESCRIPTION	CARTON
ICMPP02460	CAT 6, 24-Ports, 8P8C, 1 RMS*	16
ICMPP0245E	CAT 5e, 24-Ports, 8P8C, 1 RMS*	16

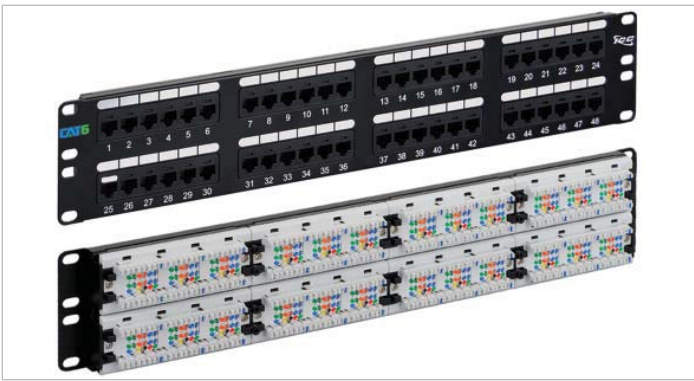

CAT 6 AND CAT 5e 48-PORT PATCH PANEL

- Fits standard 19" EIA rack mount widths
- Package includes cable ties and #12 rack screws

PART NO.	DESCRIPTION	CARTON
ICMPP04860	CAT 6, 48-Ports, 8P8C, 2 RMS*	10
ICMPP0485E	CAT 5e, 48-Ports, 8P8C, 2 RMS*	10



CAT 6 AND CAT 5e 12-PORT FRONT ACCESS ZERO-U PATCH PANELS

- Two-piece design; patch panel with removable cover
- Front access 110-Type IDC terminations
- Designed to mount on walls and distribution racks, ~~uses no rack space~~

PART NO.	DESCRIPTION	CARTON
ICMPP12F6E	CAT 6, 12-Ports, 8P8C, front access	10
ICMPP12F5E	CAT 5e, 12-Ports, 8P8C, front access	10

*1 RMS (rack mount space) = 1.75" H

DUST COVER

- Works with CAT 6A, CAT 6, CAT 5e and voice modular connectors and patch panels
- Snaps on the port opening to prevent dust from entering

PART NO.	DESCRIPTION
ICACSDCICL	Dust cover, 10 pcs.
ICACSDCVCL	Dust cover, 100 pcs. VALUEPACK

Color = Clear





VOICE 12-PORT USOC VERTICAL ZERO-U PATCH PANEL

- Two-piece design; patch panel with 89D mounting bracket
- Designed to mount on walls and distribution racks, uses no rack space
- 10" H x 3.30" W x 2.40" D
- Package includes cable ties for cable management

PART NO.	DESCRIPTION
ICMPP012U6	12-Ports, 6P6C, USOC wiring

CARTON
25



VOICE 24-PORT USOC PATCH PANEL

- Fits standard 19" EIA rack mount widths
- Package includes cable ties and #12 rack screws

PART NO.	DESCRIPTION
ICMPP024U6	24-Ports, 6P6C, USOC wiring, 1 RMS*

CARTON
15

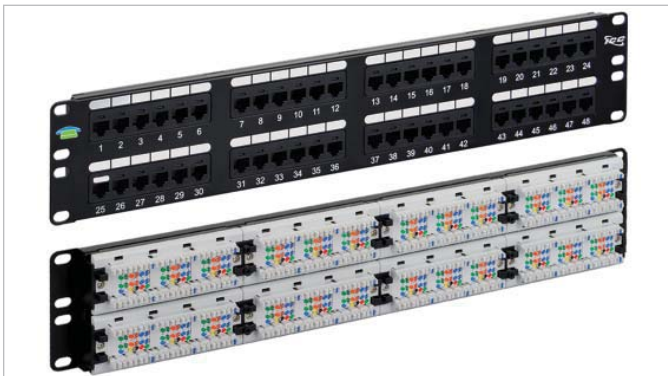

VOICE 48-PORT USOC PATCH PANEL

- Fits standard 19" EIA rack mount widths
- Package includes cable ties and #12 rack screws

PART NO.	DESCRIPTION
ICMPP048U6	48-Ports, 6P6C, USOC wiring, 2 RMS*

CARTON
10



PATCH PANEL CABLE MANAGEMENT BAR

- Mount on rear of 19" rack mount patch panels
- Works with CAT 6, CAT 5e and voice patch panels
- Designed to support terminated cable
- Durable ABS plastic

PART NO.	DESCRIPTION
ICMPP25CMB	Cable management bar

CARTON
40

*1 RMS (rack mount space) = 1.75" H

PATCH PANEL COLOR ICONS

- Apply to patch panels for system administration
- Icons are molded with text identification
- 12 icons per tree

PART NO.	DESCRIPTION
ICMPPSClxx ¹	6 voice and 6 data icons
ICMPPICDxx ¹	12 data icons
ICMPPICVxx ¹	12 voice icons





48-PORT HIGH DENSITY PATCH PANEL WITH CAT 6 AND CAT 5e FEED-THROUGH MODULAR COUPLERS

- Fits standard 19" EIA rack mount widths
- 48 modular couplers pre-installed
- Package includes #12 rack screws

PART NO.	DESCRIPTION
ICMPP48C61	48-Ports, CAT 6, 8P8C, 1 RMS*
ICMPP48C51	48-Ports, CAT 5e, 8P8C, 1 RMS*



HIGH DENSITY PATCH PANELS WITH CAT 6 FEED-THROUGH MODULAR COUPLERS

- Fits standard 19" EIA rack mount widths
- 24 modular couplers pre-installed
- Package includes #12 rack screws

PART NO.	DESCRIPTION
ICMPP24CP6	24-Ports, CAT 6, 8P8C, 1 RMS*
ICMPP48CP6	48-Ports, CAT 6, 8P8C, 2 RMS*



HIGH DENSITY PATCH PANELS WITH CAT 5e FEED-THROUGH MODULAR COUPLERS

- Fits standard 19" EIA rack mount widths
- 24 modular couplers pre-installed
- Package includes #12 rack screws

PART NO.	DESCRIPTION
ICMPP24CP5	24-Ports, CAT 5e, 8P8C, 1 RMS*
ICMPP48CP5	48-Ports, CAT 5e, 8P8C, 2 RMS*



FEED-THROUGH PATCH PANEL FEATURES

- CAT 6 or CAT 5e modular couplers pre-installed
- 50 micro-inch gold plated contacts



Connect patch cords on both ends

No assembly and no termination is required

CONFIGURABLE HIGH DENSITY BLANK PATCH PANEL

- Panel is configurable with HD style modular connectors

PART NO.	DESCRIPTION
IC107BP481	48-Ports blank, 1 RMS*



CONFIGURABLE CAT 6A UTP BLANK PATCH PANEL

- Panel is configurable with CAT 6A UTP modular connectors

PART NO.	DESCRIPTION
IC107PPU6A	24-Ports blank, 1 RMS*



CONFIGURABLE CAT 6A FTP BLANK PATCH PANEL

- Panel is configurable with CAT 6A FTP modular connectors

PART NO.	DESCRIPTION
IC107PPS6A	24-Ports blank, 1 RMS*



CONFIGURABLE HIGH DENSITY BLANK PATCH PANEL

- Panel is configurable with HD style modular connectors

PART NO.	DESCRIPTION
IC107BP241	24-Ports blank, 1 RMS*
IC107BP482	48-Ports blank, 2 RMS*

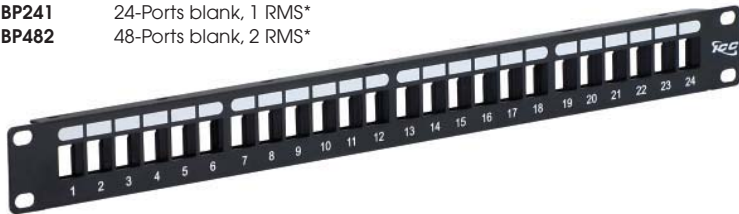

CONFIGURABLE BLANK PATCH PANEL

- Panel is configurable with EZ style modular connectors

PART NO.	DESCRIPTION
IC107BE241	24-Ports blank, 1 RMS*

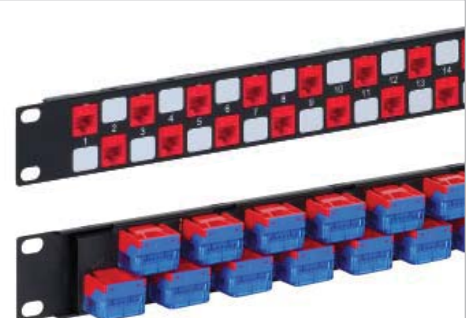

*1 RMS (rack mount space) = 1.75" H



CONFIGURABLE HIGH DENSITY WALL MOUNT VERTICAL ZERO-U BLANK PATCH PANEL

- Two-piece design; patch panel with 89U mounting bracket
- Panel is configurable with HD style modular connectors only
- 10" H x 3.30" W x 2.80" D

PART NO.	DESCRIPTION	CARTON
IC107BP12V	12-Ports blank	30



CONFIGURABLE WALL MOUNT VERTICAL ZERO-U BLANK PATCH PANEL

- Two-piece design; patch panel with 89U mounting bracket
- Panel is configurable with EZ® style modular connectors
- 10" H x 3.30" W x 2.80" D

PART NO.	DESCRIPTION	CARTON
IC107BP8VB	8-Ports blank	30

VERTICAL ZERO-U BLANK PATCH PANEL FEATURES

- Vertical patch panels are designed to mount on walls and distribution racks, uses no rack space
- They provide a flexible solution suitable as a Consolidation Point in the Work Area
- Mounting bracket acts as a channel for routing cable behind the termination

12-Port HD style

Front view

Rear view

8-Port EZ style

Front view

Rear view





VOICE 8P2C PATCH PANELS WITH REAR TELCO CONNECTORS

- Fits standard 19" EIA rack mount widths
- Package includes cable ties and #12 rack screws

PART NO.	DESCRIPTION	CARTON
ICMPP24T2C	24-Ports, active pins: 4 and 5, 1 RMS*	15
ICMPP48T2C	48-Ports, active pins: 4 and 5, 2 RMS*	10

- Male 50-Pin Telco connector(s) on the rear

ICMPP24TF2	24-Ports, active pins: 4 and 5, 1 RMS*	15
ICMPP48TF2	48-Ports, active pins: 4 and 5, 2 RMS*	10

- Female 50-Pin Telco connector(s) on the rear



VOICE 8P4C PATCH PANELS WITH REAR TELCO CONNECTORS

- Fits standard 19" EIA rack mount widths
- Package includes cable ties and #12 rack screws

PART NO.	DESCRIPTION	CARTON
ICMPP24T4C	24-Ports, active pins: 3/4 and 5/6, 1 RMS*	15
ICMPP48T4C	48-Ports, active pins: 3/4 and 5/6, 2 RMS*	15

- Male 50-Pin Telco connector(s) on the rear

ICMPP24TF4	24-Ports, active pins: 3/4 and 5/6, 1 RMS*	15
ICMPP48TF4	48-Ports, active pins: 3/4 and 5/6, 2 RMS*	15

- Female 50-Pin Telco connector(s) on the rear



VOICE 6P2C PATCH PANELS WITH REAR TELCO CONNECTORS

- Fits standard 19" EIA rack mount widths
- Package includes cable ties and #12 rack screws

PART NO.	DESCRIPTION	CARTON
ICMPP024T2	24-Ports, active pins: 3 and 4, 1 RMS*	15
ICMPP048T2	48-Ports, active pins: 3 and 4, 2 RMS*	10

- Male 50-Pin Telco connector(s) on the rear

ICMPPTF242	24-Ports, active pins: 3 and 4, 1 RMS*	15
ICMPPTF482	48-Ports, active pins: 3 and 4, 2 RMS*	10

- Female 50-Pin Telco connector(s) on the rear



VOICE 6P4C PATCH PANELS WITH REAR TELCO CONNECTORS

- Fits standard 19" EIA rack mount widths
- Package includes cable ties and #12 rack screws

PART NO.	DESCRIPTION	CARTON
ICMPP024T4	24-Ports, active pins: 3/4 and 2/5, 1 RMS*	15
ICMPP048T4	48-Ports, active pins: 3/4 and 2/5, 2 RMS*	10

- Male 50-Pin Telco connector(s) on the rear

ICMPPTF244	24-Ports, active pins: 3/4 and 2/5, 1 RMS*	15
ICMPPTF484	48-Ports, active pins: 3/4 and 2/5, 2 RMS*	10

- Female 50-Pin Telco connector(s) on the rear

*1 RMS (rack mount space) = 1.75" H

Male Telco Connector



Female Telco Connector





CAT 6 110 WIRING BLOCK KIT

- 96-Pair base with feet
- Package includes 24 4-Pair 110 connecting blocks

PART NO.	DESCRIPTION	CARTON
IC110WK966	96-Pair wiring block kit	10



CAT 5e 110 WIRING BLOCK KITS

PART NO.	DESCRIPTION	CARTON
IC110W1004	100-Pair wiring block kit	10

- 100-Pair base with feet
- Package includes 20 4-Pair and 4 5-Pair 110 connecting blocks

IC110W3004	300-Pair wiring block kit	5
------------	---------------------------	---

- 300-Pair base with feet
- Package includes 60 4-Pair and 12 5-Pair 110 connecting blocks



110 WIRING BLOCKS WITH FEET

PART NO.	DESCRIPTION	CARTON
IC110WF100	100-Pair wiring block	10
IC110WF300	300-Pair wiring block	5



110 WIRING BLOCKS WITHOUT FEET

PART NO.	DESCRIPTION	CARTON
IC110NF100	100-Pair wiring block	40
IC110NF300	300-Pair wiring block	10

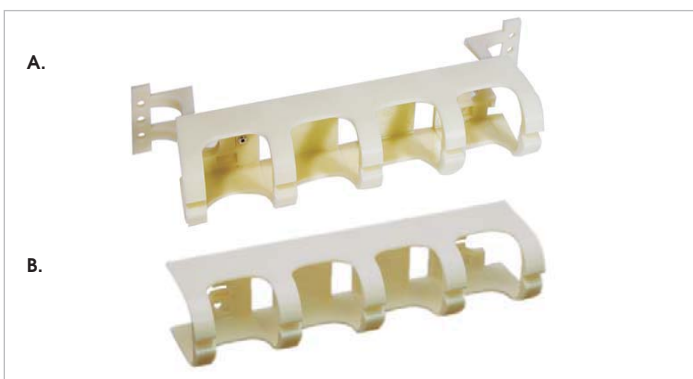

110 CABLE MANAGEMENT BLOCKS

- Works with 110 wiring blocks
- Helps organize cable

PART NO.	DESCRIPTION	CARTON
A. IC110CMBWF	Block with feet	25
B. IC110CMBNF	Block without feet	50

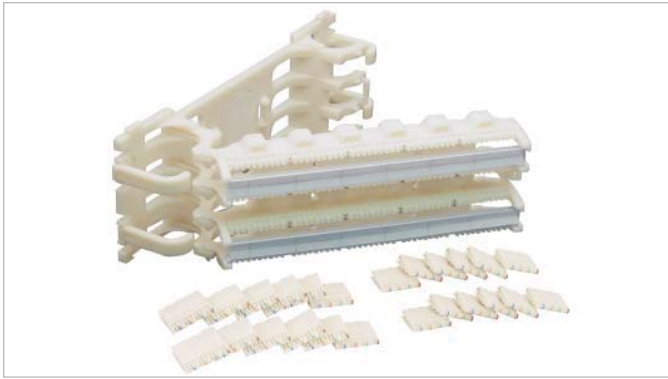

CAT 5e 110 HINGED WIRING BLOCK KIT

- 100-Pair hinged base
- Hinge design allows access to the rear of the block
- Package includes 20 4-Pair and 4 5-Pair 110 connecting blocks

PART NO.	DESCRIPTION
IC110H1004	100-Pair hinged wiring block kit

CARTON
10



110 HINGED WIRING BLOCK

- 100-Pair hinged base
- Hinge design allows access to the rear of the block

PART NO.	DESCRIPTION
IC110WH100	100-Pair hinged wiring block

CARTON
10



110 HINGED CABLE MANAGEMENT BLOCK

- Works with 110 hinged wiring blocks
- Hinge design allows access to the rear of the cable channel
- Helps organize cable

PART NO.	DESCRIPTION
IC110WHCMS	Hinged cable management block

CARTON
25

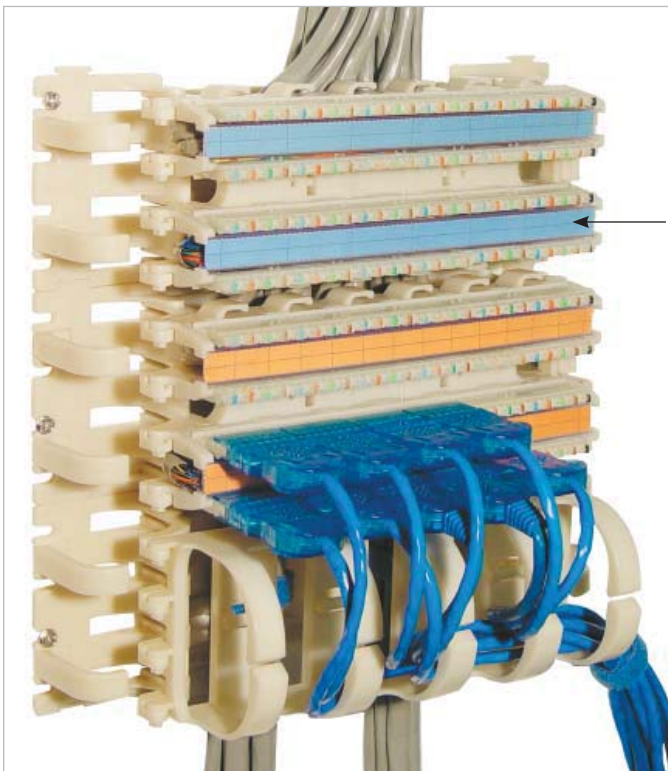

110 WIRING SYSTEM FEATURES

- High performance solution for phone and data communications
- Ideal in a Telco Room, Main Distribution Frame, Intermediate Distribution Frame and Consolidation Point

110 WIRING LABEL HOLDERS

- Use with 110 wiring blocks
- Holds and protects labels

PART NO.	DESCRIPTION
IC110HLDR	Label holders, 6 pcs.





CAT 6 RACK MOUNT 110 WIRING BLOCK PANEL KIT

- 96-Pair base with steel panel
- Fits standard 19" EIA rack mount widths
- Package includes 24 4-Pair 110 connecting blocks
- Package includes labels, label holders and #12 rack screws

PART NO.	DESCRIPTION	CARTON
IC110PRK61	96-Pair wiring block kit, 1 RMS*	15



RACK MOUNT 110 WIRING BLOCK PANELS

- Works with 3-Pair, 4-Pair and 5-Pair connecting blocks
- Fits standard 19" EIA rack mount widths
- Package includes labels, label holders and #12 rack screws

PART NO.	DESCRIPTION	CARTON
A. IC110RM100	100-Pair wiring block, 1 RMS*	15
B. IC110RM200	300-Pair wiring block, 2 RMS*	10



RACK MOUNT 110 CABLE MANAGEMENT PANEL

- Plastic clips with steel panel
- Fits standard 19" EIA rack mount widths
- Helps organize cable

PART NO.	DESCRIPTION	CARTON
IC110RMCMB	110 cable management panel, 1 RMS*	15

*1 RMS (rack mount space) = 1.75" H

Connect 110 Systems with 110 Patch Cords



← 110 patch cords
Page 74

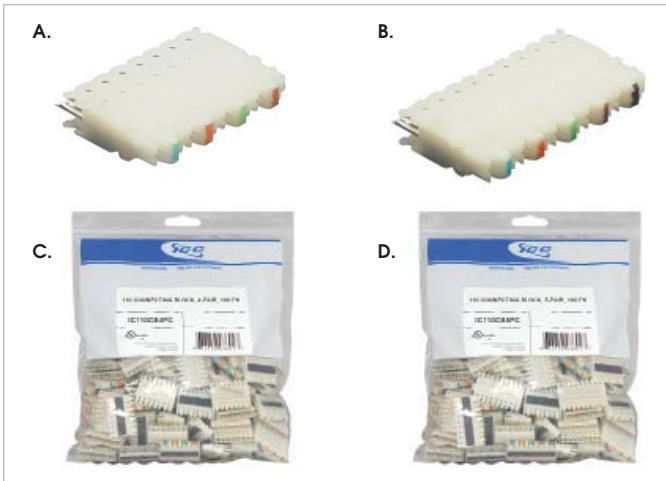

110 CONNECTING BLOCKS

- Works with 110 wiring blocks
- Supports Category 5e data
- Terminate with 22~26 AWG solid or stranded wires
- Color coded for easy termination

PART NO.	DESCRIPTION	CARTON
A. IC110CB4PR	4-Pair, 10 pcs.	300
B. IC110CB5PR	5-Pair, 10 pcs.	320
C. IC110CB4PC	4-Pair, 100 pcs. VALUEPACK	
D. IC110CB5PC	5-Pair, 100 pcs. VALUEPACK	



110 RETENTION CAP

- Secures and protects terminated wires
- Works with 110 connecting blocks and patch panels
- 50 pieces per bag

PART NO.	DESCRIPTION	CARTON
IC110TC450	4 Conductor, 2-Pair, 110 retention cap, 50 pcs.	400

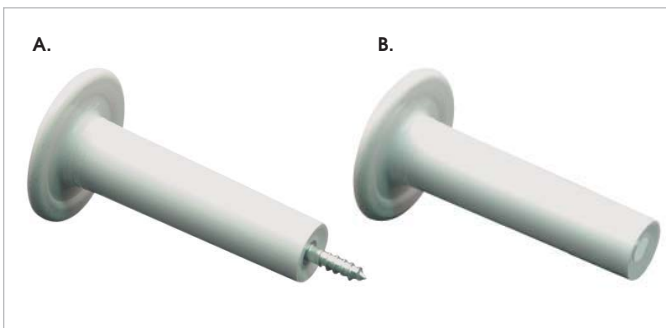

CABLE MANAGEMENT SPOOLS

- Wall mounts to help retain and guide cable
- 10 pieces per bag

PART NO.	DESCRIPTION	CARTON
A. ICACSWDS20	Spool with built-in wood screw, 10 pcs.	30
B. ICACSWDS10	Spool without screw, 10 pcs.	30

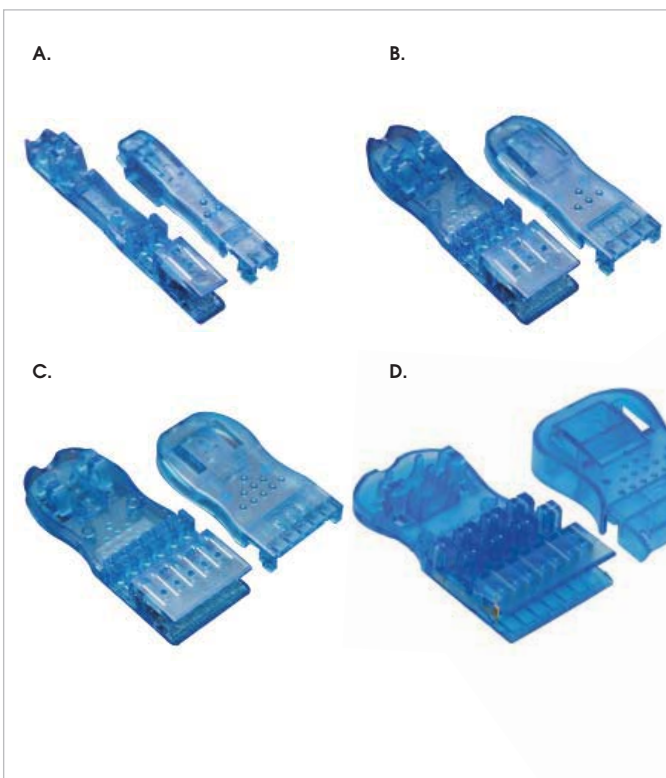

110 PATCH PLUGS

- | PART NO. | DESCRIPTION |
|---------------|------------------------------------|
| A. ICMP1101PR | Terminates 1-Pair of CAT 5e cable |
| B. ICMP1102PR | Terminates 2-Pairs of CAT 5e cable |
| C. ICMP1103PR | Terminates 3-Pairs of CAT 5e cable |
| D. ICMP1104PR | Terminates 4-Pairs of CAT 6 cable |
- Terminate with solid or stranded UTP cable

Termination tools →
Page **107**



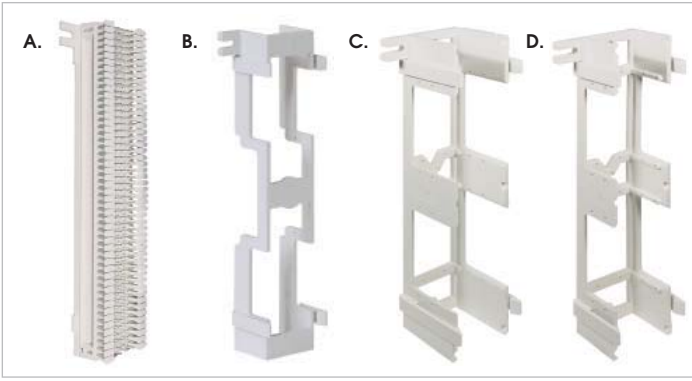

66 WIRING BLOCK, 50 PAIR

- Wall mountable
- Made of high impact flame retardant material UL 94V-0

PART NO.	DESCRIPTION
A. IC066NB050	66 wiring block

MOUNTING BRACKETS

- Snaps on the rear of 66 wiring blocks

PART NO.	DESCRIPTION
----------	-------------

B. ICMB89B0WH	89B bracket, open rear, 10" H x 3.30" W x 1.90" D
C. ICMB89D0WH	89D bracket, open front, 10" H x 3.30" W x 1.90" D
D. ICMB89U0WH	89U bracket, open front, 10" H x 3.30" W x 2.35" D

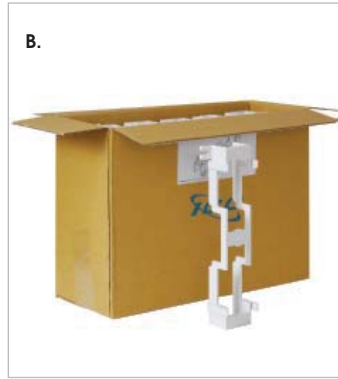

66 WIRING BLOCK AND MOUNTING BRACKET VALUEPACKS

- Packaged in a resealable box for easy storage
- Reduces packaging waste
- 25 pieces per box

PART NO.	DESCRIPTION
A. IC066NBC50	66 wiring block, 25 pcs.
B. ICMB89BCWH	89B mounting bracket, 25 pcs.

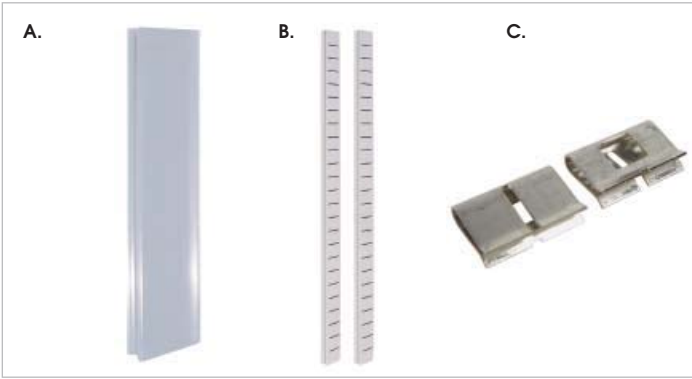

66 WIRING BLOCK COVER, LABELING STRIPS AND BRIDGING CLIPS

PART NO.	DESCRIPTION
----------	-------------

A. IC066CV050	Wiring block cover
---------------	--------------------

- Protects terminated wires from dust and debris

B. IC066LS050	Labeling strips, 10 pcs.
---------------	---------------------------------

- Use a standard labeler or pen

C. IC066BRCLP	Bridging clips, 100 pcs.
---------------	---------------------------------

- Electrically interconnect adjacent terminals within the same row

66 WIRING BLOCK SYSTEM

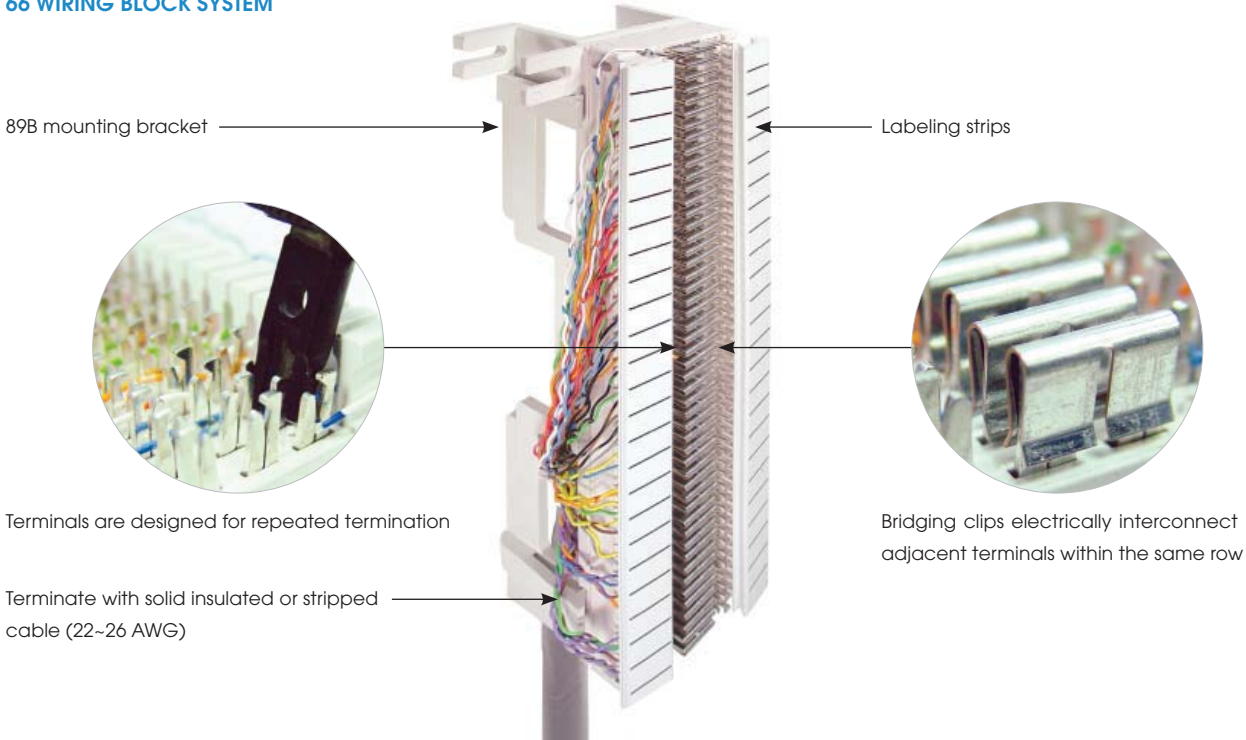



66 WIRING BLOCK PRE-WIRED WITH DATA PORTS

- Pre-wired data ports
- Integrated with 89D mounting bracket for wall mounting
- 10" H x 3.30" W x 3.00" D

PART NO.	DESCRIPTION
IC06628P8C	12-Ports, 8P8C

CARTON
25

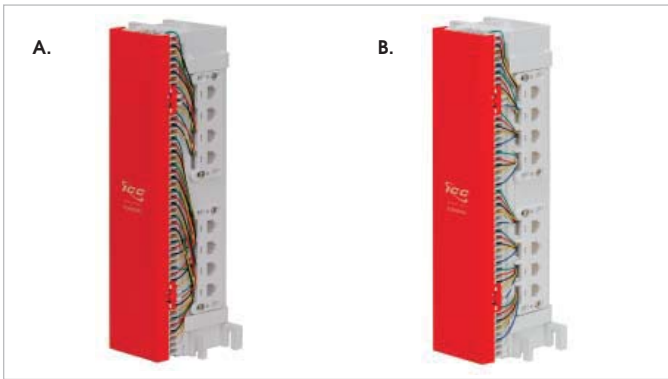

66 WIRING BLOCKS PRE-WIRED WITH VOICE PORTS

- Pre-wired voice ports
- Integrated with 89D mounting bracket for wall mounting
- 10" H x 3.30" W x 3.00" D

PART NO.	DESCRIPTION
A. IC06686P6C	8-Ports, 6P6C
B. IC06626P4C	12-Ports, 6P4C

CARTON
25
25

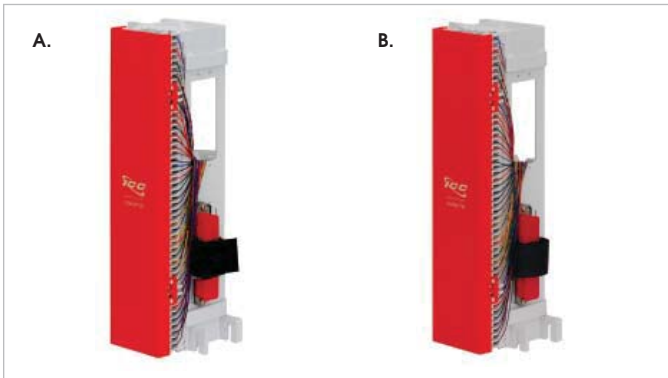

66 WIRING BLOCKS PRE-WIRED WITH TELCO CONNECTORS

- Pre-wired with 1 or 2 female Telco connectors (25/50-Pair)
- Integrated with 89D mounting bracket for wall mounting
- 10" H x 3.30" W x 3.00" D

PART NO.	DESCRIPTION
A. IC066SFT25	Pre-wired with 1 25-pair female Telco connector
B. IC066DFT50	Pre-wired with 2 25-pair female Telco connectors

CARTON
25
25

66 WIRING BLOCK PRE-WIRED WITH MODULAR CONNECTORS

66 WIRING BLOCK PRE-WIRED WITH TELCO CONNECTORS

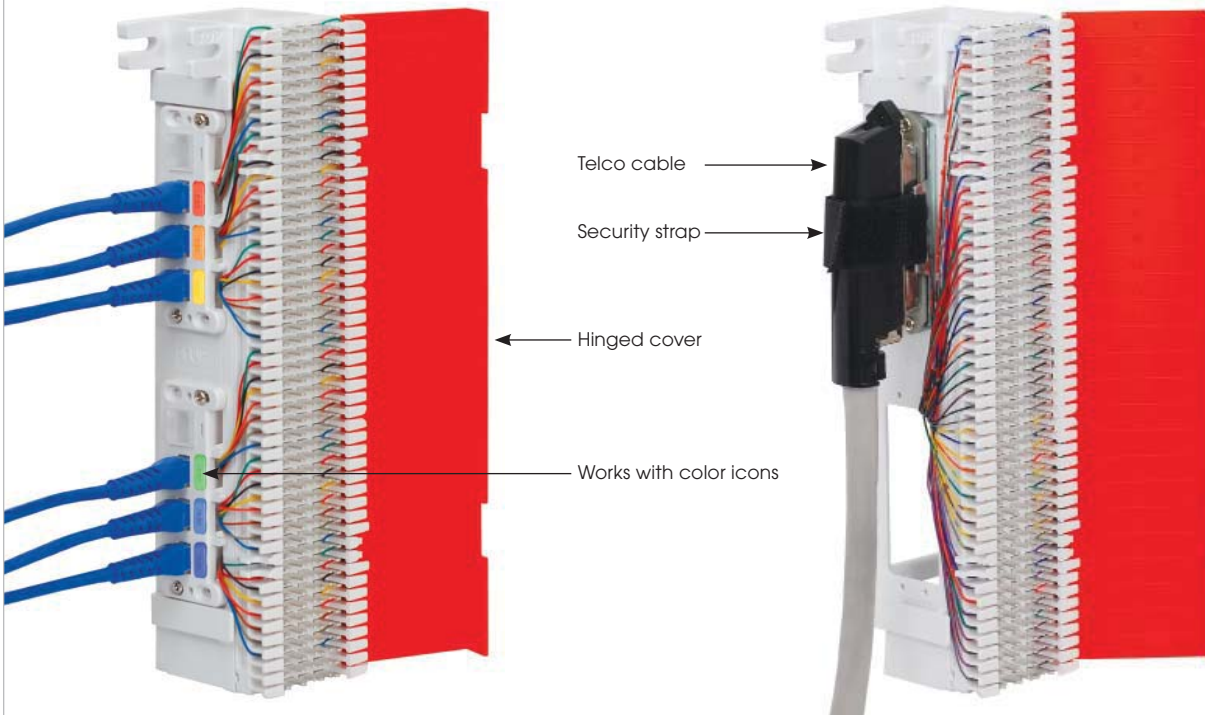

Permanent



Work Area (WA)

Horizontal Cabling

One Vendor, No Compatibility Issue

Premise cables and connectivity outlets are fine tuned to work together as End-to-End solutions. **CAT 6** Permanent Link solution including modular connectors, patch panels and premise cables stack up to **7.6dB** NEXT headroom when installed and tested per TIA specification. We also work with Elite Installers™ to offer warranty programs that are simple and effective. Using End-to-End solutions, Elite Installers can offer a **15 Year Performance Warranty** without certification. Better yet, Certified Elite Installers can verify the site and offer a **Lifetime** Performance Warranty.

Choosing the Right Cabling

Choose different category-rated cables to support any installation requirement. Premise cables exceed TIA and IEEE standards and are backwards compatible with lower category-rated products.

TIA-568-C.2 Standards	Frequency	Applications	Distance	Maximum Pair Untwist
CAT6^a	500 MHz	10/100/1000 Base-T/10 GbE, Digital Video, IEEE 802.3at for PoE Plus	100 m. (328 ft.)	13 mm. (0.5 in.)
CAT6	250 MHz	10/100/1000 Base-T, Digital Video, Phone, IEEE 802.3at for PoE Plus	100 m. (328 ft.)	13 mm. (0.5 in.)
CAT5^e	100 MHz	10/100 Base-T/1000 Base-T/ Phone	100 m. (328 ft.)	13 mm. (0.5 in.)

Protecting the Installation

- 15 Year Performance Limited Warranty™ for **Elite Installers**: no certification required
- Lifetime Performance Limited Warranty™ for **Certified Elite Installers** for verified sites
- Go online to icc.com/warranty for complete terms and conditions

Link

Telecom Room (TR)



UTP vs. FTP

- Use **Unshielded Twisted Pair** (UTP) cable in low Electromagnetic Interference (EMI) environments. UTP cable is more cost effective compared to FTP since it does not require the manufacturing cost of the shielding in FTP cable.
- Use **Foiled Twisted Pair** (FTP) cable in environments with high Electromagnetic Interference (EMI) or Radio Frequency Interference (RFI).

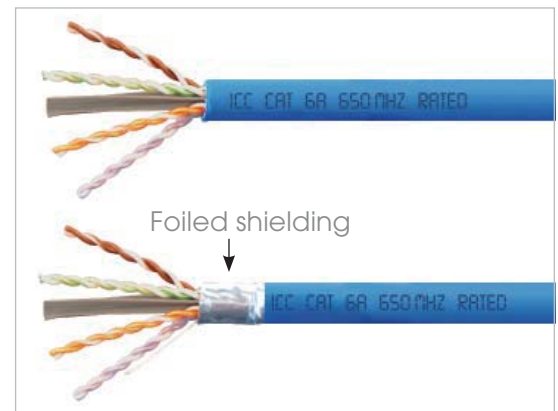

CMR vs. CMP

- Use **Riser Rated Cable** in vertical settings, such as cable runs between floors through cable risers. These spaces cannot be used for environmental air. The cable must self-extinguish to prevent the flame from traveling up the cable.
- Use **Plenum Rated Cable** in spaces like raised flooring systems and air handling ducts. Plenum cable must self-extinguish and not reignite. They produce less smoke than traditional PVC cable.



Premium Quality

- With stringent quality control procedures, premise cables have been inspected and tested to comply with the strict FCC®, TIA® and UL® standards.
- Premise cables are Restriction of Hazardous Substance (RoHS) compliant to protect the environment.



CAT 6A UTP 650 MHz 10G PREMISE CABLES

- 4-Pair, 23 AWG, UTP, solid copper cable
- Designed with an X separator
- 0.34" outer diameter
- Packaged on a reel; 13.0" H x 17.3" W
- 1000 feet per reel (305 meters)



PART NO.	DESCRIPTION	PALLET
ICCABP6Axx ¹	CAT 6A UTP cable, CMP (Plenum)	15
ICCABR6Axx ¹	CAT 6A UTP cable, CMR (Riser)	15

Color (xx¹) = BL WH

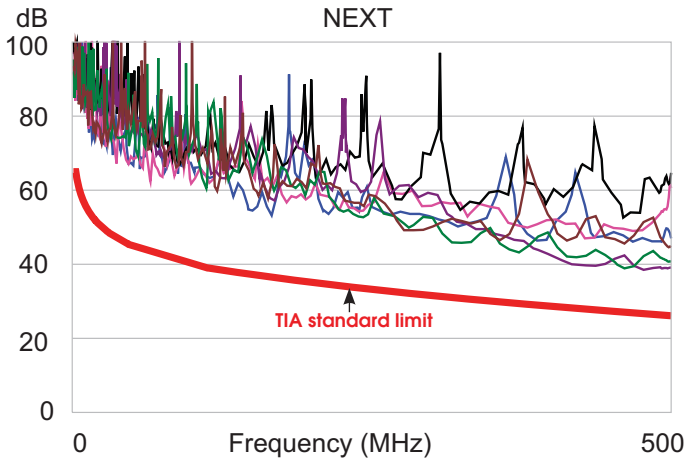

Tested per TIA Channel Link specification

CAT 6A FTP 650 MHz 10G PREMISE CABLES

- 4-Pair, 23 AWG, FTP, solid copper cable
- Shielded jacket protects from EMI and RFI noise
- Designed with an X separator
- 0.34" outer diameter
- Packaged on a reel; 13.0" H x 17.3" W
- 1000 feet per reel (305 meters)



PART NO.	DESCRIPTION	PALLET
ICCABP6Fxx ¹	CAT 6A FTP cable, CMP (Plenum)	15
ICCABR6Fxx ¹	CAT 6A FTP cable, CMR (Riser)	15

Color (xx¹) = BL

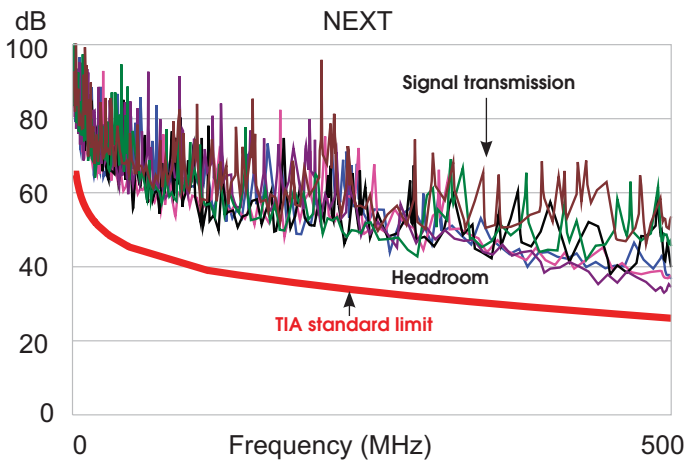

Tested per TIA Channel Link specification

CAT 6e UTP 600 MHz PREMISE CABLES

- 4-Pair, 23 AWG, UTP, solid copper cable
- Designed with an X separator
- 0.234" outer diameter
- Packaged in an EZ pull box; 15.55" H x 9.60" W x 15.75" D
- 1000 feet per box (305 meters)



PART NO.	DESCRIPTION	PALLET
ICCABP6Exx ¹	CAT 6e UTP cable, CMP (Plenum)	36
ICCABR6Exx ¹	CAT 6e UTP cable, CMR (Riser)	30

Color (xx¹) = BL WH GY YL GN

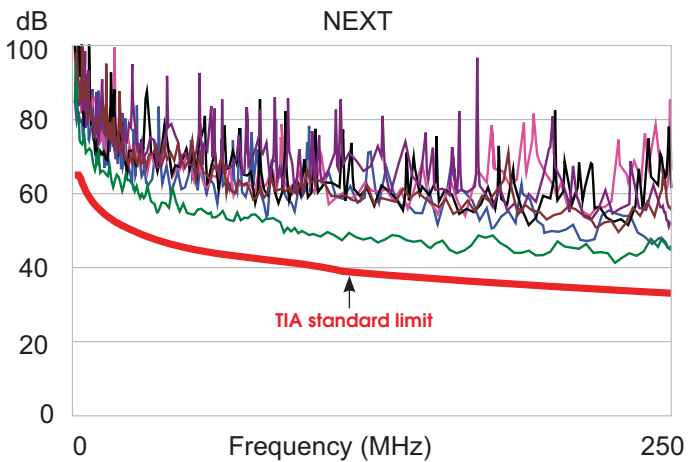

Tested per TIA Channel Link specification

CAT 6A UTP 650 MHz 10G PREMISE CABLE PERFORMANCE CHART

FREQUENCY (MHz)	1	10	16	62.5	100	200	250	350	500	600	650
ATTENUATION (max)	2.1	5.9	7.5	15.0	19.1	27.6	31.1	37.2	45.3	50.1	52.3
RETURN LOSS (min)	20.0	27.0	27.0	23.5	22.1	20.0	19.3	18.3	17.5	16.9	16.7
NEXT (min)	78.3	63.3	60.2	51.4	48.3	43.8	42.3	40.1	37.8	36.6	36.1
PS NEXT (min)	76.3	61.3	58.2	49.4	46.3	41.8	40.3	38.1	35.8	34.6	34.1
ACR (min)	71.8	51.8	47.7	35.9	31.8	25.8	23.8	20.9	17.8	-	-
PS ACR (min)	68.8	48.8	44.7	32.9	28.8	22.8	20.8	17.9	14.8	-	-
ACRF (min)	67.0	67.0	67.0	65.6	62.5	58.0	56.5	54.3	52.0	-	-
PS ACRF (min)	67.0	58.2	54.1	42.3	38.2	32.2	30.2	27.3	24.2	-	-

CAT 6A FTP 650 MHz 10G PREMISE CABLE PERFORMANCE CHART

FREQUENCY (MHz)	1	10	16	62.5	100	200	250	350	500	600	650
ATTENUATION (max)	2.1	5.9	7.5	15.0	19.1	27.6	31.1	37.2	45.3	50.1	52.3
RETURN LOSS (min)	20.0	27.0	27.0	23.5	22.1	20.0	19.3	18.3	17.5	16.9	16.7
NEXT (min)	78.3	63.3	60.2	51.4	48.3	43.8	42.3	40.1	37.8	36.6	36.1
PS NEXT (min)	76.3	61.3	58.2	49.4	46.3	41.8	40.3	38.1	35.8	34.6	34.1
ACR (min)	71.8	51.8	47.7	35.9	31.8	25.8	23.8	20.9	17.8	-	-
PS ACR (min)	68.8	48.8	44.7	32.9	28.8	22.8	20.8	17.9	14.8	-	-
ACRF (min)	67.0	67.0	67.0	65.6	62.5	58.0	56.5	54.3	52.0	-	-
PS ACRF (min)	67.0	58.2	54.1	42.3	38.2	32.2	30.2	27.3	24.2	-	-

CAT 6e UTP 600 MHz PREMISE CABLE PERFORMANCE CHART

FREQUENCY (MHz)	1	10	16	62.5	100	200	250	350	500	600	
ATTENUATION (max)	2.0	5.9	7.4	14.9	19.1	27.7	31.2	37.5	45.8	50.7	
RETURN LOSS (min)	21.0	25.5	26.0	26.0	22.5	19.8	19.0	17.8	16.2	15.7	
NEXT (min)	82.3	67.3	64.2	55.4	52.3	47.8	46.3	45.7	44.8	44.2	
PS NEXT (min)	80.3	65.3	62.2	53.4	50.3	45.8	44.3	43.7	42.8	42.2	
ACR (min)	80.3	61.4	56.8	40.4	33.2	20.1	15.1	8.2	0.0	-	
PS ACR (min)	78.3	59.4	54.8	38.4	31.2	18.1	13.1	6.2	-	-	
ACRF (min)	73.8	53.8	49.7	37.9	33.9	27.8	25.8	22.9	19.8	18.2	
PS ACRF (min)	71.8	51.8	47.7	35.9	31.8	25.8	23.8	20.9	17.8	16.2	

CAT 6 UTP 500 MHz PREMISE CABLES, PLENUM

- 4-Pair, 23 AWG, UTP, solid copper cable
- 0.200" outer diameter
- Packaged in an EZ pull box; 15.50" H x 10.25" W x 15.50" D
- 1000 feet per box (305 meters)



PART NO. ICCABP6Vxx¹	DESCRIPTION CAT 6 UTP cable, CMP (Plenum)	PALLET 30
Color (xx¹) =	BL WH GY YL GN	

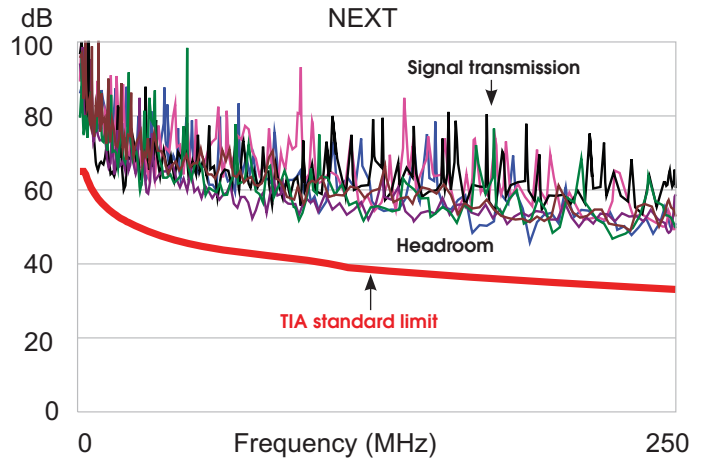

Tested per TIA Channel Link specification

CAT 6 UTP 500 MHz PREMISE CABLES, RISER

- 4-Pair, 23 AWG, UTP, solid copper cable
- 0.039" outer diameter
- Packaged in an EZ pull box; 14.57" H x 9.45" W x 15.35" D
- 1000 feet per box (305 meters)



PART NO. ICCABR6Vxx¹	DESCRIPTION CAT 6 UTP cable, CMR (Riser)	PALLET 36
Color (xx¹) =	BL WH GY YL GN	

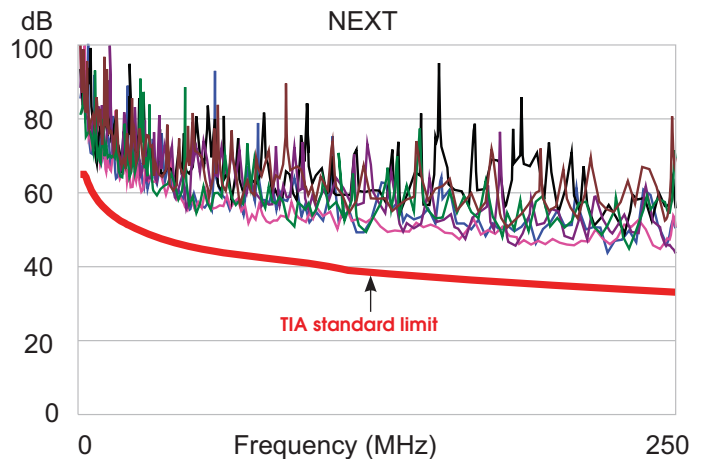

Tested per TIA Channel Link specification

CAT 5e UTP 350 MHz PREMISE CABLES

- 4-Pair, 24 AWG, UTP, solid copper cable
- 0.177" outer diameter
- Packaged in an EZ pull box; 14.37" H x 8.97" W x 14.56" D
- 1000 feet per box (305 meters)

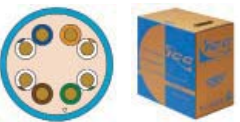

PART NO. ICCABP5Exx¹ ICCABR5Exx¹	DESCRIPTION CAT 5e UTP cable, CMP (Plenum) CAT 5e UTP cable, CMR (Riser)	PALLET 39 45
Color (xx¹) =	BL WH GY YL GN	

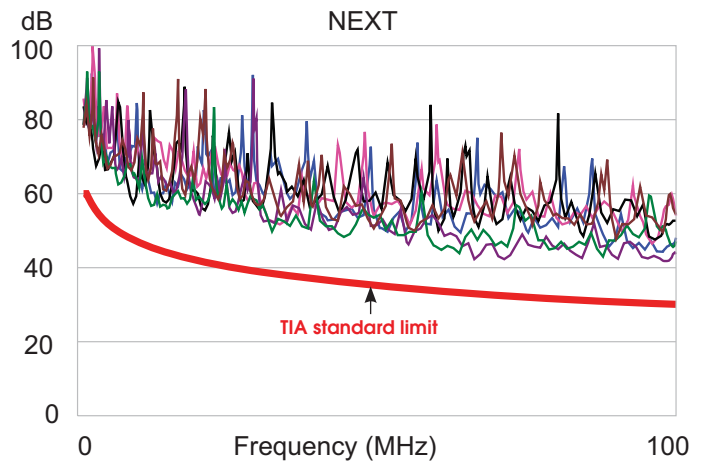

Tested per TIA Channel Link specification

CAT 6 UTP 500 MHz PLENUM PREMISE CABLE PERFORMANCE CHART

FREQUENCY (MHz)	1	10	16	62.5	100	200	250
ATTENUATION (max)	2.0	6.0	7.6	15.4	19.8	29.0	32.8
RETURN LOSS (min)	20.0	25.0	25.0	21.5	20.1	18.0	17.3
NEXT (min)	74.3	59.3	56.2	47.4	44.3	39.8	38.3
PS NEXT (min)	72.3	57.3	54.2	45.4	42.3	37.8	36.3
ACR (min)	72.3	53.3	48.7	32.0	24.5	10.8	5.5
PS ACR (min)	70.3	51.3	46.7	29.9	22.5	8.8	3.5
ACRF (min)	67.8	47.8	43.7	31.8	27.8	21.8	19.8
PS ACRF (min)	64.8	44.8	40.7	28.9	24.8	18.8	16.8

CAT 6 UTP 500 MHz RISER PREMISE CABLE PERFORMANCE CHART

FREQUENCY (MHz)	1	10	16	62.5	100	200	250
ATTENUATION (max)	2.0	6.0	7.6	15.4	19.8	29.0	32.8
RETURN LOSS (min)	20.0	25.0	25.0	21.5	20.1	18.0	17.3
NEXT (min)	74.3	59.3	56.3	47.4	44.3	39.8	38.3
PS NEXT (min)	72.3	57.3	54.3	45.1	42.3	37.8	36.3
ACR (min)	72.3	53.3	48.7	32.0	24.5	10.8	5.5
PS ACR (min)	70.3	51.3	46.7	30.0	22.5	8.8	3.5
ACRF (min)	67.8	47.8	43.7	31.8	27.8	21.7	19.8
PS ACRF (min)	64.8	44.8	40.7	28.8	24.8	18.7	16.8

CAT 5e UTP 350 MHz PREMISE CABLE PERFORMANCE CHART

FREQUENCY (MHz)	1	10	16	62.5	100	200	250
ATTENUATION (max)	2.0	6.3	8.0	16.0	20.5	29.5	33.2
RETURN LOSS (min)	21.0	26.0	26.0	22.5	21.1	19.0	18.3
NEXT (min)	70.3	55.3	52.2	43.4	40.3	35.8	34.3
PS NEXT (min)	68.3	53.3	50.2	41.4	38.3	33.8	32.3
ACR (min)	68.3	49.0	44.2	27.3	19.8	6.3	1.2
PS ACR (min)	66.3	47.0	42.2	25.3	17.8	4.3	0
ACRF (min)	67.8	47.8	43.7	31.9	27.8	21.8	19.8
PS ACRF (min)	64.8	44.8	40.7	28.9	24.8	18.8	16.8

Hinged Wall Mount Brackets

- **Limited space / closet installations**
- Available in EZ-Fold or regular style
- Supports up to 60 lb. of equipment

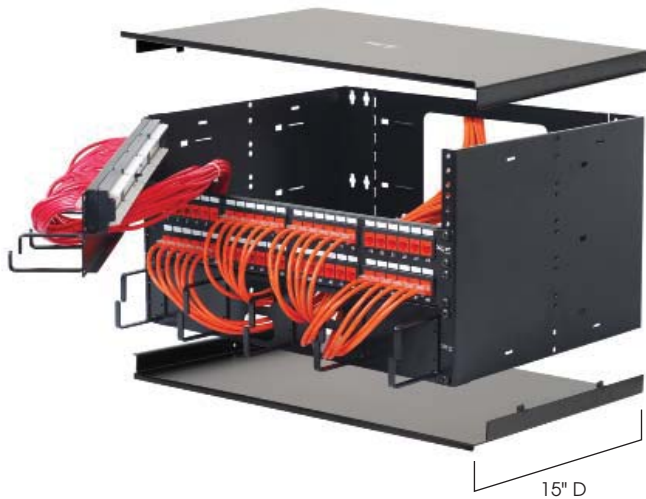

Fixed Frame Wall Mount Racks

- **Limited floor space / small room installations**
- Self-squaring design; easy to assemble
- Supports up to 125 lb. of equipment



Swing Gate Wall Mount Racks

- **Small room / space for swing out**
- Swing out to access rear cable or equipment
- Supports up to 150 lb. of equipment



Floor Mount Distribution Racks

- **Regulation size Telecom Rooms**
- Available with 2 and 4 posts
- Supports up to 1500 lb. of equipment



HINGED WALL MOUNT BRACKET FEATURES

- Large rear opening for cable entry
- Standard EIA-310-D hole pattern
- Roll tapped threading limits rack screws from stripping
- 0.25" wall mounting holes
- Heavy duty 16 gauge steel
- Optional cover can be mounted on top only



EZ-FOLD WALL MOUNT BRACKET FEATURES

- Unfold to 6 inch depth
- No weight bearing at the hinge
- Heavy duty 16 gauge steel

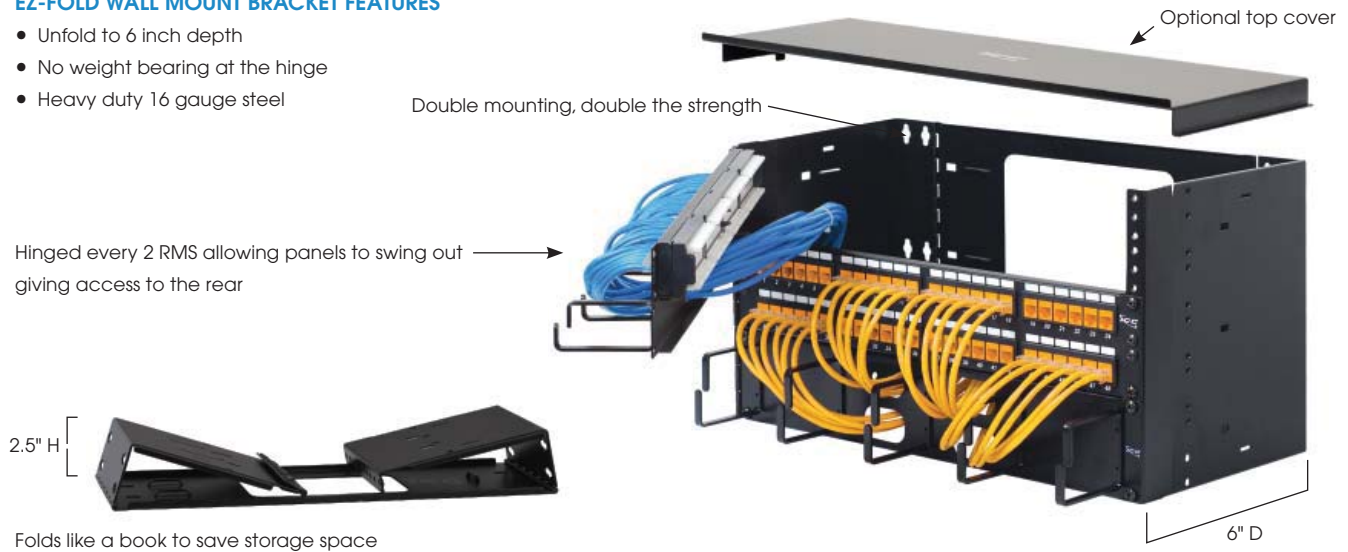

EZ-FOLD WALL MOUNT BRACKET FEATURES

- No weight bearing at the hinge
- Hinged every 2 RMS for easy upgrade access and maintenance
- Double mounting, double the strength
- Heavy duty 16 gauge steel

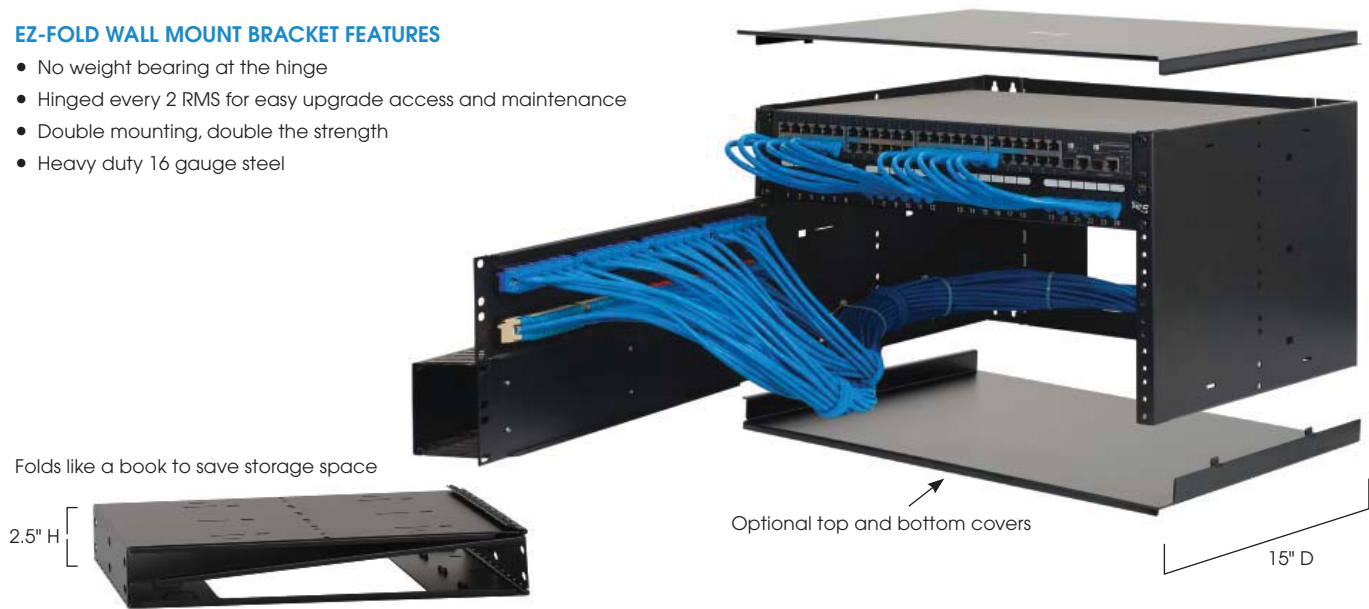

HINGED WALL MOUNT BRACKETS, 6" DEPTH

- Designed with heavy duty steel supporting up to 40 lb. of equipment
- 6" depth for network and phone equipment
- Package includes #10 wood screws and #12 rack screws

PART NO.	DESCRIPTION
ICCMShBCVR	Wall mount bracket cover, 1 pc.
ICCMShB1RS	1.75" H x 19.31" W x 6" D, 10 lb. capacity, 1 RMS*
ICCMShB1RC	1.75" H x 19.31" W x 6" D, 10 lb. capacity, 1 RMS*, 2 pcs. VALUEPACK
ICCMShB2RS	3.50" H x 19.31" W x 6" D, 20 lb. capacity, 2 RMS*
ICCMShB2RC	3.50" H x 19.31" W x 6" D, 20 lb. capacity, 2 RMS*, 2 pcs. VALUEPACK
ICCMShB4RS	7.00" H x 19.31" W x 6" D, 40 lb. capacity, 4 RMS*
ICCMShB4RC	7.00" H x 19.31" W x 6" D, 40 lb. capacity, 4 RMS*, 2 pcs. VALUEPACK



EZ-FOLD WALL MOUNT BRACKETS, 6" DEPTH

- Designed with heavy duty steel supporting up to 30 lb. of equipment
- 6" depth for network and phone equipment
- Package includes #12 rack screws

PART NO.	DESCRIPTION
ICCMShBCVR	Wall mount bracket cover, 1 pc.
ICCMsABR62	3.50" H x 19.30" W x 6" D, 30 lb. capacity, 2 RMS*
ICCMsABR64	7.00" H x 19.30" W x 6" D, 30 lb. capacity, 4 RMS*
ICCMsABR66	10.50" H x 19.30" W x 6" D, 30 lb. capacity, 6 RMS*
ICCMsABR68	14.00" H x 19.30" W x 6" D, 30 lb. capacity, 8 RMS*



EZ-FOLD WALL MOUNT BRACKETS, 15" DEPTH

- Designed with heavy duty steel supporting up to 30 lb. of equipment
- 15" depth for network and phone equipment
- Package includes #12 rack screws

PART NO.	DESCRIPTION
ICCMsABRSC	Wall mount bracket cover kit, top and bottom covers, 2 pcs.
ICCMsABRS2	3.50" H x 19.30" W x 15" D, 30 lb. capacity, 2 RMS*
ICCMsABRS4	7.00" H x 19.30" W x 15" D, 30 lb. capacity, 4 RMS*
ICCMsABRS6	10.50" H x 19.30" W x 15" D, 30 lb. capacity, 6 RMS*
ICCMsABRS8	14.00" H x 19.30" W x 15" D, 30 lb. capacity, 8 RMS*



*1 RMS (rack mount space) = 1.75" H

WALL MOUNT RACK FEATURES

- 18" depth for network and phone equipment
- Standard EIA-310-D hole pattern
- 0.25" wall mounting holes
- Steel construction for strength and durability

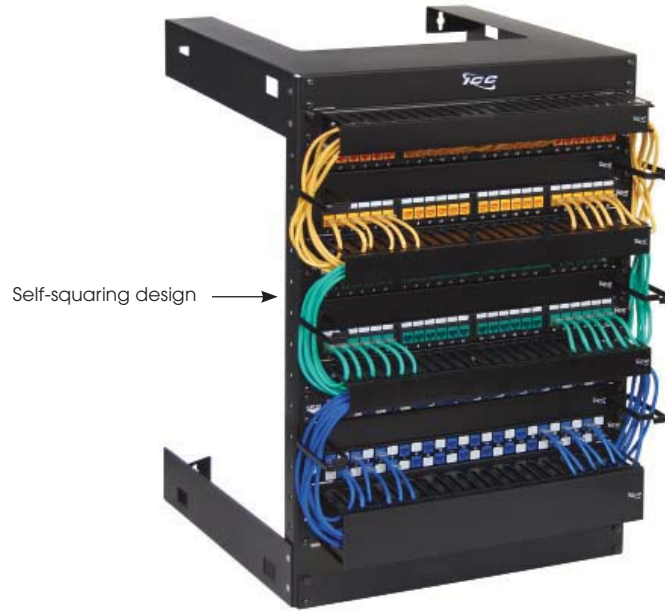

SWING FRAME WALL MOUNT RACK FEATURES

- Assemble and install in four easy steps
- Supports up to 85 lb.
- The frame is designed to swing outward
- Standard EIA-310-D hole pattern
- Steel construction for strength and durability

The frame can be installed to swing open left or right →

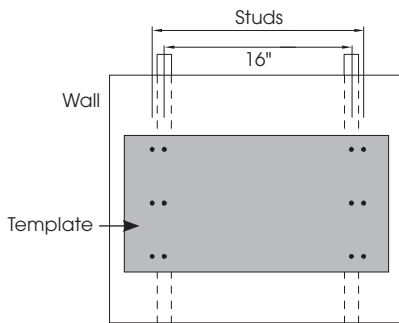

Package includes a template to mark holes

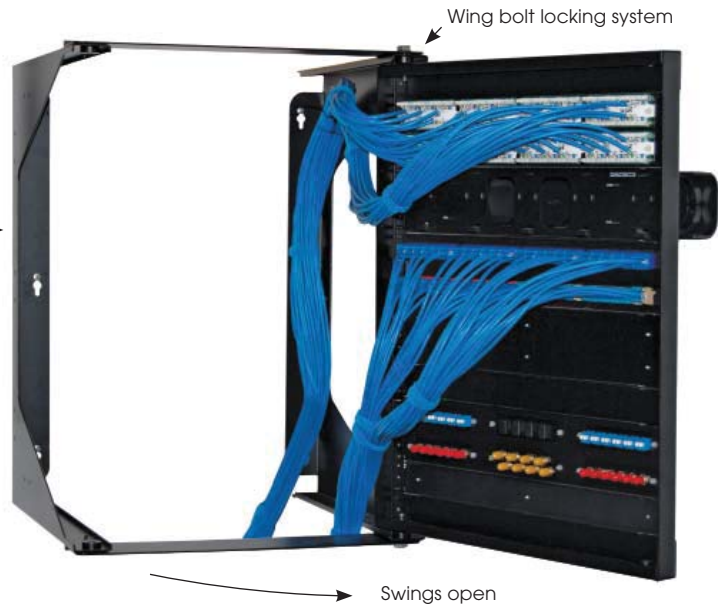

SWING GATE WALL MOUNT RACK FEATURES

- Swings open left or right for quick and easy access
- Punch down while fully open
- 150 lb. weight capacity
- Standard EIA-310-D hole pattern
- 0.25" wall mounting holes
- Steel construction for strength and durability

The frame can be installed to swing open left or right →

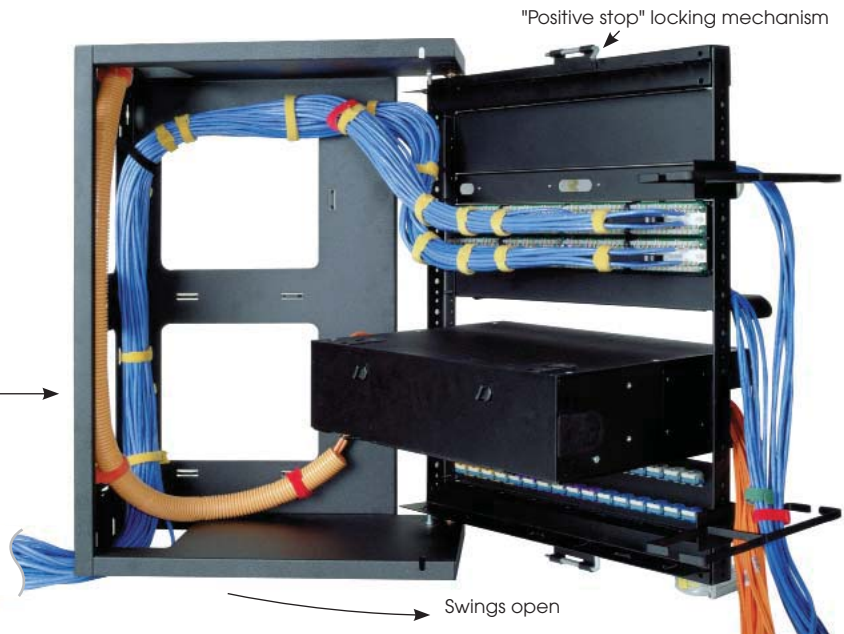

WALL MOUNT RACKS, 18" DEPTH

- Designed with heavy duty steel, supporting up to 125 lb. of equipment
- Package includes #12 rack screws

PART NO.	DESCRIPTION
ICCMSWMR08	17.75" H x 19.75" W x 18" D, 8 RMS*
ICCMSWMR15	30.00" H x 19.75" W x 18" D, 15 RMS*
ICCMSWMR30	56.25" H x 19.75" W x 18" D, 30 RMS*



ICCMSWMR08



ICCMSWMR15

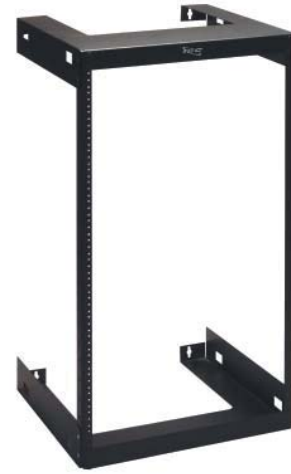

ICCMSWMR30

SWING FRAME WALL MOUNT RACKS, 18" DEPTH

- Designed with heavy duty steel, supporting up to 85 lb. of equipment
- Package includes #12 rack screws

PART NO.	DESCRIPTION
ICCMSSFR12	25.60" H x 19.50" W x 18"D, 85 lb. capacity, 12 RMS*
ICCMSSFR25	49.13" H x 19.50" W x 18"D, 85 lb. capacity, 25 RMS*



ICCMSSFR12



ICCMSSFR25

SWING GATE WALL MOUNT RACKS, 19" DEPTH

- Designed with heavy duty steel, supporting up to 150 lb. of equipment
- Package includes #12 rack screws

PART NO.	DESCRIPTION
ICCMSSGR21	27" H x 20.5" W x 19" D, 150 lb. capacity, 12 RMS*
ICCMSSGR22	41" H x 20.5" W x 19" D, 150 lb. capacity, 20 RMS*



ICCMSSGR21

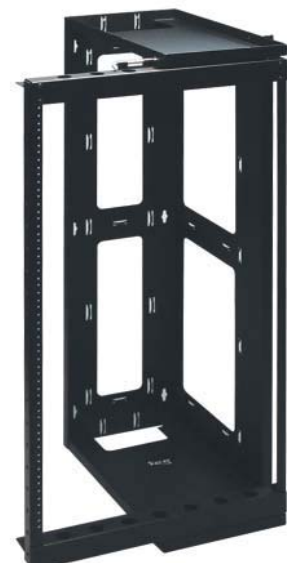

ICCMSSGR22

*1 RMS (rack mount space) = 1.75" H

VERTICAL HINGED WALL MOUNT BRACKET FEATURES

- Mounting rails tilt downward for easy access to rear equipment
- Rail is designed with twist-lock to secure mounted equipment
- The frame comes assembled
- 0.25" wall mounting holes
- Supports up to 60 lb. of equipment
- Steel construction for strength and durability
- Package includes #12 rack screws

PART NO.	DESCRIPTION
ICCMSVHB06	12.75" H x 19.75" W x 12" D, 40 lb. capacity, 6 RMS*
ICCMSVHB08	16.25" H x 19.75" W x 12" D, 60 lb. capacity, 8 RMS*
ICCMSVHB18	16.25" H x 19.75" W x 18" D, 60 lb. capacity, 8 RMS*

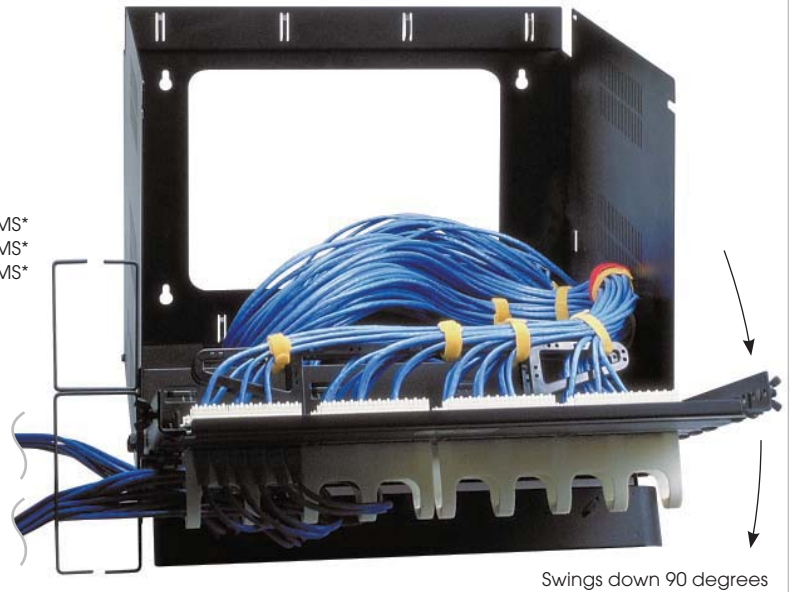

ICCMSVHB06



ICCMSVHB08



ICCMSVHB18

UTILITY WALL MOUNT RACK

- Suitable for areas where floor or wall space is limited
- Standard EIA-310-D hole pattern
- 0.25" wall mounting holes
- Steel construction for strength and durability
- Package includes #12 rack screws

PART NO.	DESCRIPTION
ICCMSWMUR5	Wall mount utility rack, 5 RMS*

75 lb. weight capacity →



Equipment mounts vertically →

*1 RMS (rack mount space) = 1.75" H

2-POST DISTRIBUTION RACKS

- 19" EIA rack mount width
- Supports up to 750 lb. when floor anchored
- Lightweight aluminum construction

PART NO.	DESCRIPTION
ICCMSR1984	7' H, 45 RMS*
ICCMSR1972	6' H, 38 RMS*
ICCMSR1948	4' H, 24 RMS*
ICCMSRFLKT	Concrete rack mount kit



ICCMSRFLKT ICCMSR1948 ICCMSR1972 ICCMSR1984

ADJUSTABLE 4-POST DISTRIBUTION RACK

- Designed to be adjusted from 27" and up to 32" depth
- Works with 4-post rack shelves
- 19" EIA rack mount width
- Side rail holes for linking racks or vertical cable channels
- Supports up to 1500 lb. when properly loaded and floor anchored
- Lightweight aluminum construction
- Mounts to concrete floor with optional anchor kit

PART NO.	DESCRIPTION
ICCMSR4P84	7' H, 45 RMS*
ICCMSRFLKT	Concrete rack mount kit

The rails on all racks have Rack Mount Space (RMS) numbered markings

Rack is designed to adjust from 27" up to 32" depth



*1 RMS (rack mount space) = 1.75" H

CABLE MANAGEMENT RACK

- 19" EIA rack mount width
- Designed with side rail holes for linking racks
- Supports up to 1000 lb. when floor anchored
- Mounts to concrete floor with optional anchor kit
- Lightweight aluminum construction

PART NO.	DESCRIPTION
ICCMSCMRH7	7' H, 44 RMS*
ICCMSRFLKT	Concrete rack mount kit



Integrated with 6" depth x 3.15" width cable channels along both sides of rails

Numbered markings



VERTICAL CABLE CHANNEL AND COVER

- Joins two 2-Post or 4-Post distribution racks together
- Front swivel latches for easy cable assembly
- Large rear openings for simplified cable routing
- Lightweight aluminum construction
- 6.5" H x 6" W x 6.10" D

PART NO.	DESCRIPTION
ICCMSCC6BK	6.5" H vertical cable channel
ICCMSCCVBK	3" H vertical cable channel cover

2 covers are required to cover 1 cable channel



ICCMSCCVBK



Cable channels can be mounted back to back



ICCMSCC6BK



*1 RMS (rack mount space) = 1.75" H

SINGLE-SIDED VERTICAL FINGER DUCT PANELS, 4" W X 5" D

- Package includes cover and #12 rack screws



PART NO.	DESCRIPTION
ICCMSCMA84	78" H, front, flat mount, brackets on one side
ICCMSCMA81	78" H, front, side mount, brackets on one side
ICCMSCMA21	35" H, front, side mount, brackets on one side

DOUBLE-SIDED VERTICAL FINGER DUCT PANELS, 4" W X 10" D

- Package includes cover and #12 rack screws



PART NO.	DESCRIPTION
ICCMSCMA83	78" H, front and rear, side mount, brackets on one side
ICCMSCMA82	78" H, front and rear, center mount, brackets on both sides
ICCMSCMA23	35" H, front and rear, side mount, brackets on one side
ICCMSCMA22	35" H, front and rear, center mount, brackets on both sides

FINGER DUCT PANEL FEATURES

- Route and manage large amounts of cable
- Designed with flexible fingers for easy cable routing
- Durable plastic



Slide-on and removable covers



Rear feed-through holes



MOUNTING OPTIONS



Center Mount

Brackets on both sides to interconnect two racks



Side Mount

Bracket on one side, mounts on either side of the rack's rear rails

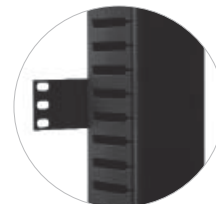

Flat Mount

Flat bracket on side, works with ICCMSCMRH7 rack

HORIZONTAL FINGER DUCT PANELS

- Available in single and double-sided styles
- Designed with flexible fingers for easy cable routing
- Fits standard 19" EIA rack mount widths
- Package includes cover and #12 rack screws



PART NO.	DESCRIPTION
A. ICCMSCMA41	Single-sided, 1.75 H x 19" W x 3.25" D, 1 RMS*
B. ICCMSCMA42	Single-sided, 3.50" H x 19" W x 3.25" D, 2 RMS*
C. ICCMSCMA61	Double-sided, 1.75" H x 19" W x 7.10" D, 1 RMS*
D. ICCMSCMA62	Double-sided, 3.50" H x 19" W x 7.10" D, 2 RMS*

PLASTIC RING AND INTERBAY PANELS

- Plastic rings for easy cable routing
- Base is designed with openings for rear cable access and with cable tie anchor points
- Fits standard 19" EIA rack mount widths
- Package includes cover and #12 rack screws



PART NO.	DESCRIPTION
A. ICCMSCMA51	Interbay panel, 1.75" H x 19" W x 3.88" D, 1 RMS*
B. ICCMSCMA52	Interbay panel, 3.50" H x 19" W x 3.88" D, 2 RMS*
C. ICCMSCMA31	Ring panel, 1.75" H x 19" W x 3.88" D, 1 RMS*
D. ICCMSCMA32	Ring panel, 3.50" H x 19" W x 3.88" D, 2 RMS*

*1 RMS (rack mount space) = 1.75" H

METAL RING AND INTERBAY PANELS

- Steel construction for strength and durability
- Base is designed with openings for rear cable access
- Fits standard 19" EIA rack mount widths
- Package includes #12 rack screws

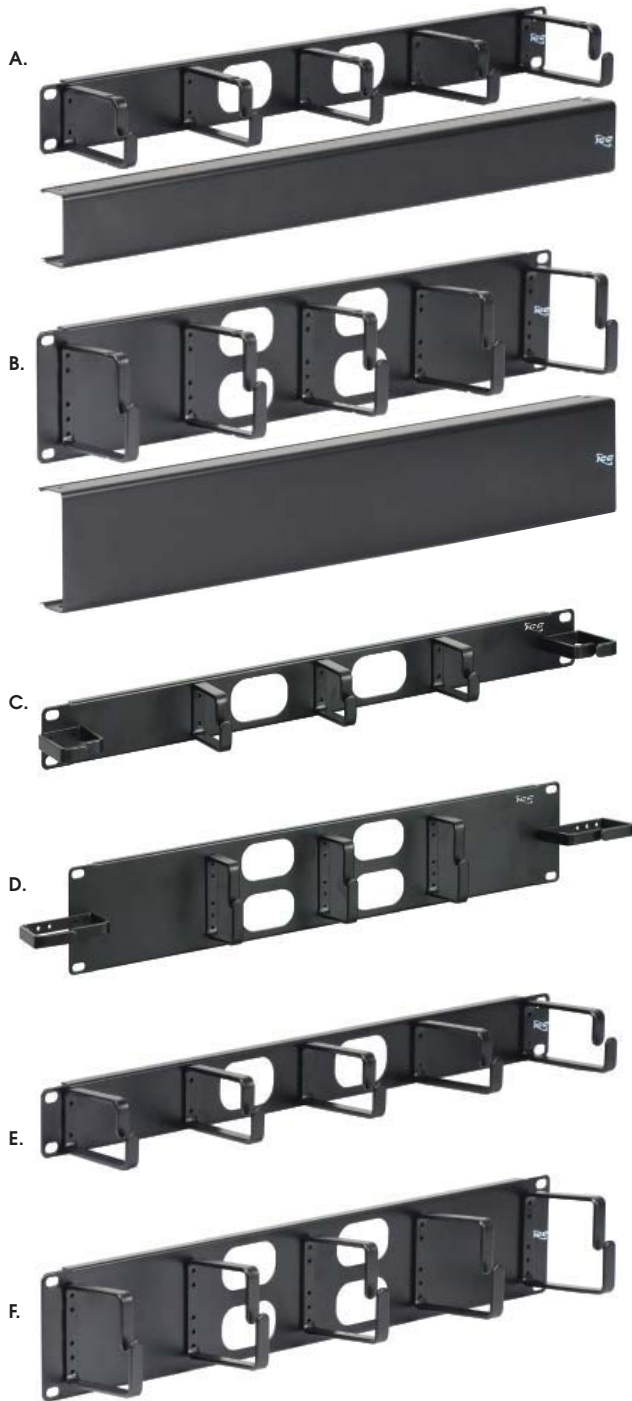

PART NO.	DESCRIPTION
A. ICCMSCMPK1	Ring panel and cover, 1.75" H x 19" W x 3" D, 1 RMS*
B. ICCMSCMPK2	Ring panel and cover, 3.50" H x 19" W x 3" D, 2 RMS*
C. ICCMSCMP31	Ring panel, 1.75" H x 19" W x 2.83" D, 1 RMS*
D. ICCMSCMP32	Ring panel, 3.50" H x 19" W x 2.83" D, 2 RMS*
E. ICCMSCMP51	Interbay panel, 1.75" H x 19" W x 3" D, 1 RMS*
F. ICCMSCMP52	Interbay panel, 3.50" H x 19" W x 3" D, 2 RMS*

*1 RMS (rack mount space) = 1.75" H

EXTENDED BRACKETS AND BLANK PANELS

- Extended brackets are designed for front or rear cable management
- No extra rack mount spaces are needed
- Blank panels fill empty spaces between mounted equipment
- Both fit standard 19" EIA rack mount widths
- Package includes #12 rack screws

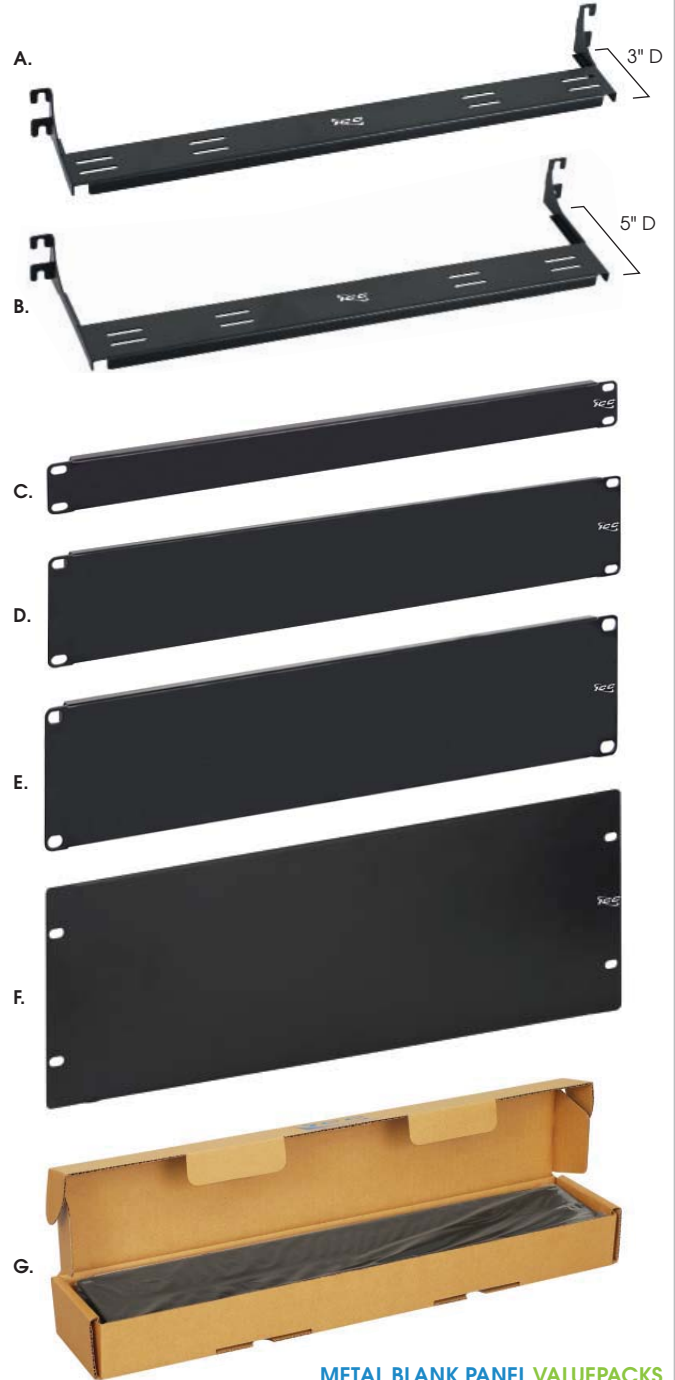

PART NO.	DESCRIPTION	CARTON
A. ICCMSFCMRP	Front extended bracket, 3" deep	
B. ICCMSRCMRP	Rear extended bracket, 5" deep	
C. ICCMSCMPB1	Blank panel, 1.75" H x 19" W, 1 RMS*	60
D. ICCMSCMPB2	Blank panel, 3.50" H x 19" W, 2 RMS*	40
E. ICCMSCMPB3	Blank panel, 5.25" H x 19" W, 3 RMS*	30
F. ICCMSCMPB4	Blank panel, 7.00" H x 19" W, 4 RMS*	30
G. ICCMSCMPC1	Blank panel, 1.75" H x 19" W, 1 RMS*, 12 pcs. VALUEPACK	
	ICCMSCMPC2 Blank panel, 3.50" H x 19" W, 2 RMS*, 12 pcs. VALUEPACK	
	ICCMSCMPC3 Blank panel, 5.25" H x 19" W, 3 RMS*, 6 pcs. VALUEPACK	
	ICCMSCMPC4 Blank panel, 7.00" H x 19" W, 4 RMS*, 6 pcs. VALUEPACK	

METAL BLANK PANEL VALUEPACKS



UNIVERSAL PLASTIC RING, 3" HEIGHT X 3" WIDTH

- Mount on the sides of racks to route cable vertically and horizontally
- Mount between distribution racks to join them together
- Durable ABS plastic

PART NO.	DESCRIPTION
ICCMSCMPR7	3" H x 3" W single ring, universal

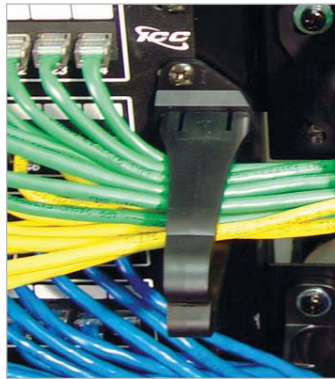

PLASTIC RING, 1.25" HEIGHT

- Mount on the sides of racks to route cable horizontally
- Durable ABS plastic

PART NO.	DESCRIPTION
ICCMSCMPR6	1.25" H single ring, horizontal



PLASTIC RING, 1.25" WIDTH

- Mount on the sides of racks to route cable vertically
- Durable ABS plastic

PART NO.	DESCRIPTION
ICCMSCMPR5	1.25" W single ring, vertical



FRONT AND REAR PLASTIC RING, 3" HEIGHT X 3" WIDTH

- Mount between distribution racks to route cable vertically
- Designed with a steel frame
- Durable ABS plastic

PART NO.	DESCRIPTION
ICCMSCMPR8	3" H x 3" W dual rings, vertical



FRONT AND REAR PLASTIC RING, 3" HEIGHT X 3" WIDTH

- Mount between distribution racks to route cable horizontally
- Designed with a steel frame
- Durable ABS plastic

PART NO.	DESCRIPTION
ICCMSCMPR9	3" H x 3" W dual rings, horizontal